

Contract no. A832-059

Development of Species Profiles for
Selected Organic Emission Sources

April 30, 1991

California Polytechnic State University

Prepared for California Air Resources Board

Albert C. Censullo, Ph. D.

Final Report

on

Development of Species Profiles for Selected Organic Emission Sources

Volume II: Engine Exhaust Emissions

Prepared by

Albert C. Censullo, Ph. D.
Chemistry Department
California Polytechnic State University

ABSTRACT

This project involved the characterization of fugitive emissions from three source categories. Category 1 sources comprised emissions from California oil production facilities. Site selection criteria were developed, and resulted in the generation of a prioritized list of locations where emissions from light, medium and heavy crude petroleum operations would be sampled. At each site, samples from wellhead, pipeline, processing and storage systems were obtained. Specific components for sampling were pre-screened for positive hydrocarbon emissions using a portable hydrocarbon analyzer. The sampling methodology involved collection of 38 samples in evacuated stainless steel canisters. Detailed emission species profiles were determined by gas chromatography, with flame ionization detection. Peak identification was based on retention times, as well as separate gas chromatographic runs using a mass selective detector.

Category 2 and 3 sources included exhaust from utility and heavy-duty engines. The selection of 21 samples, based on estimates of engine populations in California, was described. The design and fabrication of a portable exhaust dilution system was discussed. Diluted exhaust from selected engines was sampled simultaneously for hydrocarbons and aldehydes. Diesel engines were additionally sampled for higher hydrocarbons. Hydrocarbon species were collected into evacuated stainless steel canisters. Aldehydes were absorbed into midget impingers containing DNPH/acetonitrile. High molecular weight hydrocarbons from Diesel exhaust were adsorbed in sorbent tubes filled with XAD-2 resin. Hydrocarbons were speciated by gas chromatographic techniques, as with Category 1 sources. Analysis of DNPH-aldehyde derivatives was performed using high performance liquid chromatography. Extracts from the XAD-2 resin were analyzed by gas chromatography, using a mass selective detector.

DISCLAIMER

The statements and conclusions in this report are those of the contractor and not necessarily those of the California Air Resources Board. The mention of commercial products, their source or use in connection with material reported herein is not to be construed as either an actual or implied endorsement of such products.

Table of Contents

I. Introduction.....	1
II. Category 2 and Category 3 Sources	1
A. Background.....	1
B. Sample Selection Criteria.....	1
C. Sampling Methodology	14
1. Sampling Tunnel Design.....	14
2. Sampling for Hydrocarbons in Exhaust	21
3. Sampling for Aldehydes	21
4. Sampling for High Molecular Weight Hydrocarbons	27
D. Quality Assurance	27
E. Analytical Methodologies.....	27
F. Engine Sampling.....	30
G. Format for Results	32
H. Results.....	32
1. Aldehyde Analysis Results	32
I. Discussion.....	54
1. Aldehyde Results	54
2. Hydrocarbon Replicate Samples.....	58
3. Aldehyde and Ketone Concentrations	58
4. Hydrocarbon Concentrations.....	58
III. References Cited	68

LIST OF APPENDICES

Appendix A - Hydrocarbon References	69
Appendix B - Aldehyde References	71
Appendix C - Photographs of Selected Sampling Setups.....	73
Appendix D - Protocol for Sampling Engine Exhaust Emissions	78
Appendix E - Analytical Methodologies.....	79

List Of Figures

Figure 1 - Team Personnel.....	3
Figure 2 - Review of Aldehydes in Engine Exhaust.....	6
Figure 3 - Category 2 Source Distribution.....	7
Figure 4 - Horsepower of Category 2 Sources.....	8
Figure 5 - Category 2 Source Populations.....	9
Figure 6 - Category 3 Source Populations.....	10
Figure 7 - Category 3 Sources, Continued.....	11
Figure 8- Comparison of Farm Equipment Populations.....	12
Figure 9 - Possible Sampling Methods for HC and RCHO.....	15
Figure 10 - CVS Sampling Scheme.....	16
Figure 11 - No Dilution Sampling.....	17
Figure 12 - Sun MGA-90 Analyzer.....	18
Figure 13 - Literature Dilution Tunnel.....	19
Figure 14 - Dilution Tunnel Schematic.....	20
Figure 15 - Tunnel Construction Details.....	23
Figure 16- Hydrocarbon Sampling Train.....	24
Figure 17 - Derivatization of Aldehydes.....	25
Figure 18 - Aldehyde Sampling Train.....	26
Figure 19 - XAD Cartridge Design.....	29
Figure 20 - Category 2 Major Exhaust Components.....	66
Figure 21 - Category 3 Major Exhaust Components.....	67

List of Tables

Table 1 - Category 2 and 3 Sources	4
Table 2 - Category 2 Sample Selection.....	5
Table 3 - Category 3 Sample Selection.....	13
Table 4 - Engine Tests.....	31
Table 5 - ET-01 Results.....	33
Table 6 - ET-02 Results.....	34
Table 7 - ET-03 Results.....	35
Table 8 - ET-04 Results.....	36
Table 9 - ET-05 Results.....	37
Table 10 - ET-06 Results	38
Table 11 - ET-07 Results	39
Table 12 - ET-09 Results	40
Table 13 - ET-10 Results	41
Table 14 - ET-11 Results	42
Table 15 - ET-12 Results	43
Table 16 - ET-13 Results	44
Table 17 - ET-15 Results	45
Table 18 - ET-17 Results	46
Table 19- ET-18 Results	47
Table 20 - ET-20 Results	48
Table 21 - ET-21 Results	49
Table 22 - ET-23 Results.....	50
Table 23 - ET-25 Results	51
Table 24 - ET-26 Results	52
Table 25 - ET-27 Results	53
Table 26 - Impinger Breakthrough Study (ET-1)	55
Table 27 - Analytical Precision (ET-18).....	56
Table 28 - Sampling Precision (ET-10 and ET-11).....	57
Table 29- Engine Test Duplicate ET-10 and ET-11	60
Table 30 - Engine Test Duplicate ET-17 and ET-18.....	61
Table 31 - Aldehyde Contribution to Carbonyl Compounds	62
Table 32 - Formaldehyde Content of Sources.....	63
Table 33 - Category 2 Source Summary	64
Table 34 - Category 3 Source Summary	65

SUMMARY

In accordance with the Request for Proposal issued by the California Air Resources Board, this project involved the characterization of hydrocarbon and aldehyde emissions from a variety of sources. This report deals with Task 1 of that project, the development of a plan for sampling and analysis, as well as the Task 2 implementation of the approved sampling plan. Sources to be sampled were divided into three categories:

Category 1 - Oil Production Fugitive Emissions

Category 2 - Utility Engine Exhaust

Category 3 - Farm and Heavy-Duty Engine Exhaust

CATEGORY 1 SOURCES

As originally proposed, 38 samples from this category were to be collected and analyzed. The numerous components in an oil production field were segregated into "systems". These systems were classified as wellhead, pipeline, processing and storage. Each of these systems is progressively farther from the well than the preceding system. A sampling matrix was developed, consisting of various systems in fields producing light, medium and heavy crude oil. Samples from two secondary sumps were collected from a flux chamber in SUMMA electropolished, evacuated stainless steel canisters. Storage tank headspace samples were collected in evacuated steel canisters. Samples from other systems were obtained by isolating the selected component(s) with a Teflon shroud, and collecting the shroud effluent in evacuated steel canisters. Additional samples from several sources were taken by direct connection of the evacuated canisters to pipe fittings in the distribution lines, using Teflon tubing. Analyses for desired hydrocarbon constituents were performed using a variety of validated chromatographic methods. Details on this portion of the study are reported separately, in Volume I of this report.

CATEGORY 2 AND 3 SOURCES

Using estimates of engine populations in California, a ranking of these sources was developed. Classification was based on engine type, rather than equipment type. A total of 13 samples from Category 2, and 8 samples from Category 3 was recommended for sampling. Sampling for these sources involved dilution of the engine exhaust in a portable mini-tunnel. Hydrocarbons were collected in evacuated stainless steel canisters, while aldehydes were derivatized in DNPH/acetonitrile filled midjet impingers.. High molecular weight hydrocarbons were adsorbed in XAD-2 sorbent tubes. Hydrocarbon analysis were performed using gas chromatographic methods. Aldehyde derivatives were analyzed using high performance liquid chromatography. Extracts from XAD resin were analyzed by GC-MS.

Final Report

I. Introduction

The general objective of this project was "to develop improved hydrocarbon species profiles for oil production equipment, and exhaust from utility and heavy-duty equipment". (ARB RFP, Feb. 1988). These species profiles, when multiplied by the appropriate emission rate factors, will yield detailed information on the mass emission rates for specific compounds. This report is divided into two volumes. The first volume deals with Category 1 sources (Oil Field Fugitive Emissions). This second volume discusses all aspects of Category 2 and 3 sources (Engine Tests). To address the various technical aspects of the project, a team of researchers was assembled. Team personnel, and their primary roles in this portion of the investigation, are shown in Figure 1 .

II. Category 2 and Category 3 Sources

A. Background

Category 2 sources contain engines with horsepower in the range of 1 to 20. These "utility" engines cover a wide range of applications, as shown in Table 1. Category 3 sources, heavy duty equipment, encompass engines from 20 to 99+ horsepower . In addition to determining hydrocarbon composition (as with Category 1 sources), characterization of aldehyde emissions from these sources was also performed. In order to access the results of previous related studies, a literature search was performed. These references, sorted by year, are shown in Appendix A. Similarly, sorted aldehyde references are listed in Appendix B. The original literature was reviewed for information needed to design the sampling system. A summary of pertinent facts about aldehyde emissions extracted from the literature is shown in Figure 2.

B. Sample Selection Criteria

As outlined in the original proposal, a total of twenty sources, distributed approximately equally between Category 2 and Category 3, were to be sampled for hydrocarbon and aldehyde speciation. In order to assign a priority to each item within a given category, information about the population of each item was sought. In 1983, the Mobile Source Control Division of the California Air Resources Board completed an emissions inventory¹ of equipment in these categories. Values listed in this report were used as a starting point for current California engine populations. A graphical representation of these data (Figure 3) clearly shows the dominance of residential lawn mowers to Category 2 sources. A histogram of engine horsepower (Figure 4) reveals that most engines are in the 3 to 6 horsepower range. While the number of engine units presently in California is likely not exactly the same as reported by ARB in 1983, evidence will be presented later to support the contention that the 1983 estimates are reasonably close to the current populations. Category 2 sampling information is summarized in Table 2. Based on the large number of

lawnmowers in use in California, four of the selected samples were lawnmowers in various configuration and size classes.

A similar analysis was performed for sources in Category 3. Again, earlier ARB estimates were used as a starting point for the populations shown in Figures 5, 5, and 7. Figures recently tabulated in Implement and Tractor² listed 1978 and 1988 populations for farm equipment, both nationally as well as from within California. For the number of sources tabulated, the differences between 1978 and 1988 populations were on the order of $\pm 10\%$. This is illustrated graphically in Figure 7. The dashed line at zero on the graph corresponds to no change in the 1988 population, relative to 1978. A total of 8 sources from Category 3 was selected for sampling. Category 3 sampling information is summarized in Table 3. While Category 3 comprises a large number of equipment types, many of these items contain similar engines. Thus, during the selection process, an attempt was made to focus on engine types, rather than equipment types. For example, industrial tractors utilize engines similar (or identical) to those used in farm tractors. The same is true for many of the other non-farm equipment items. The sources shown in Table 3 were selected on the basis of engine units, rather than equipment units.

Figure 1 - Project Personnel

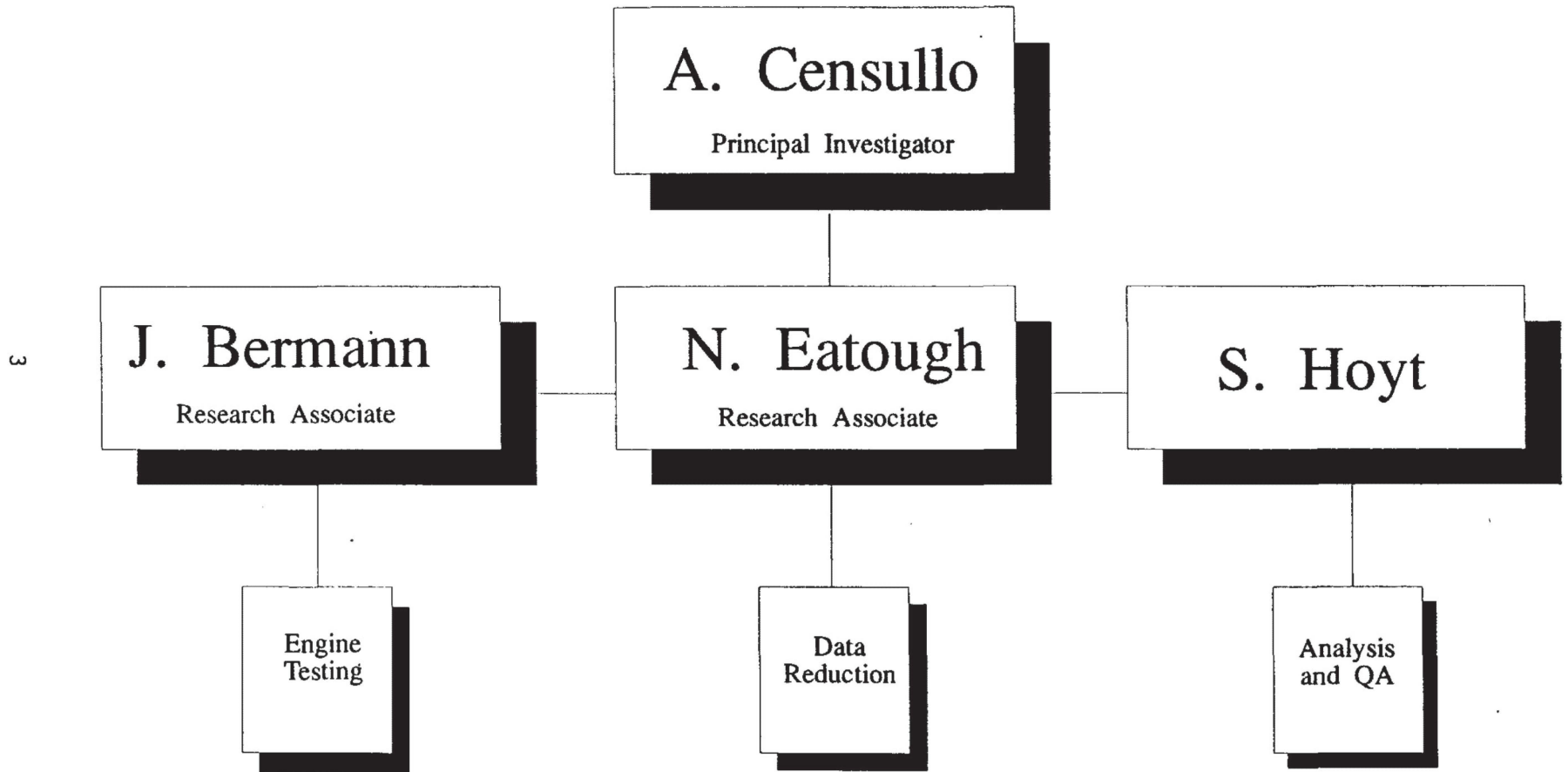

Table 1 - Category 2 and 3 Sources

CATEGORY 2 - UTILITY EQUIPMENT EXHAUST

Horsepower	Commercial	Residential
1.0 - 3.0	Misc. Lawn and Garden	Misc. Lawn and Garden
3.1 - 5.0	Chain Saws Push Mowers	Chain Saws Push Mowers Rototillers General Utility
5.1 - 10.0	Rototillers	
10.1 - 15.0	Garden Tractors	Garden Tractors

CATEGORY 3 - HEAVY DUTY EQUIPMENT EXHAUST

FARM

- | | |
|-----------------------------------|---------------------------|
| 1. Agricultural Tractor, 20-99 hp | 6. Windrower |
| 2. Agricultural Tractor, 99+ hp | 7. Cotton Picker |
| 3. Track Type Tractor, 20-89 hp | 8. Forage Harvester |
| 4. Track Type Tractor, 90+ hp | 9. Track Loader, 20-89 hp |
| 5. Combine | 10. Skid Steer Loader |

NON-FARM

- | | |
|-------------------------------------|-----------------|
| 1. Tractor, Industrial | 9. Motor Grader |
| 2. Ditcher / Trencher | 10. Compactor |
| 3. Loader, Wheel Type 2.5 cu. yd | 11. Crane |
| 4. Loader, Wheel Type 2.5 + cu. yd. | 12. Scraper |
| 5. Loader, Track Type , 20-89 hp | 13. Excavator |
| 6. Loader, Track Type ,90+ hp | 14. Log Skidder |
| 7. Tractor, Track Type , 20-89 hp | 15. Paver |
| 8. Tractor, Track Type , 90+ hp | |

Table 2 - Category 2 Sample Selection

Item	Category	# of Samples
3.1-5 hp lawnmower	2	3
1-3 hp lawnmower	2	2
1-3 hp string trimmer	2	1
1-3 hp edger	2	1
3.1-5 hp chainsaw	2	1
1-3 hp chainsaw	2	1
1-3 hp leaf blower	2	1
3.1-5 hp rototiller	2	1
5.1-10 hp rototiller	2	1
10-15 hp riding mower	2	1
		13

Figure 2

ALDEHYDES IN ENGINE EXHAUST

- **2 - 10 % OF TOTAL HYDROCARBONS WILL BE ALDEHYDES**
- **60 -90 % OF ALDEHYDES WILL BE HCHO**
- **RCHO EMISSIONS IN METHANOL ENGINES IS ROUGHLY 10X THAT OF GASOLINE ENGINES**
- **ROUGHLY 20 % OF EMITTED ALDEHYDES WILL BE IN TAILPIPE CONDENSATE**
- **CONCENTRATIONS EXPECTED: 1-50 PPM IN UNDILUTED EXHAUST**

Figure 3 - Category 2 Source Distribution

CATEGORY 2 SOURCES

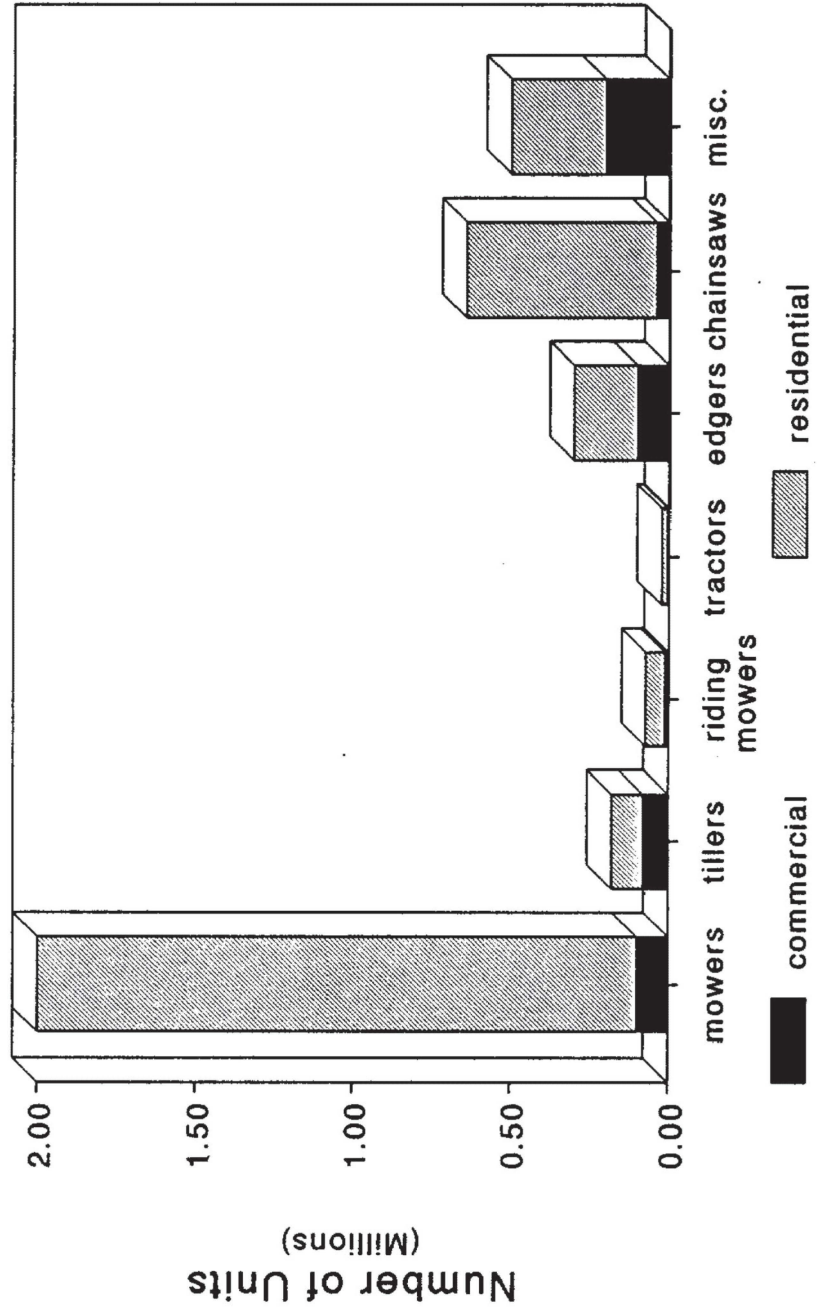
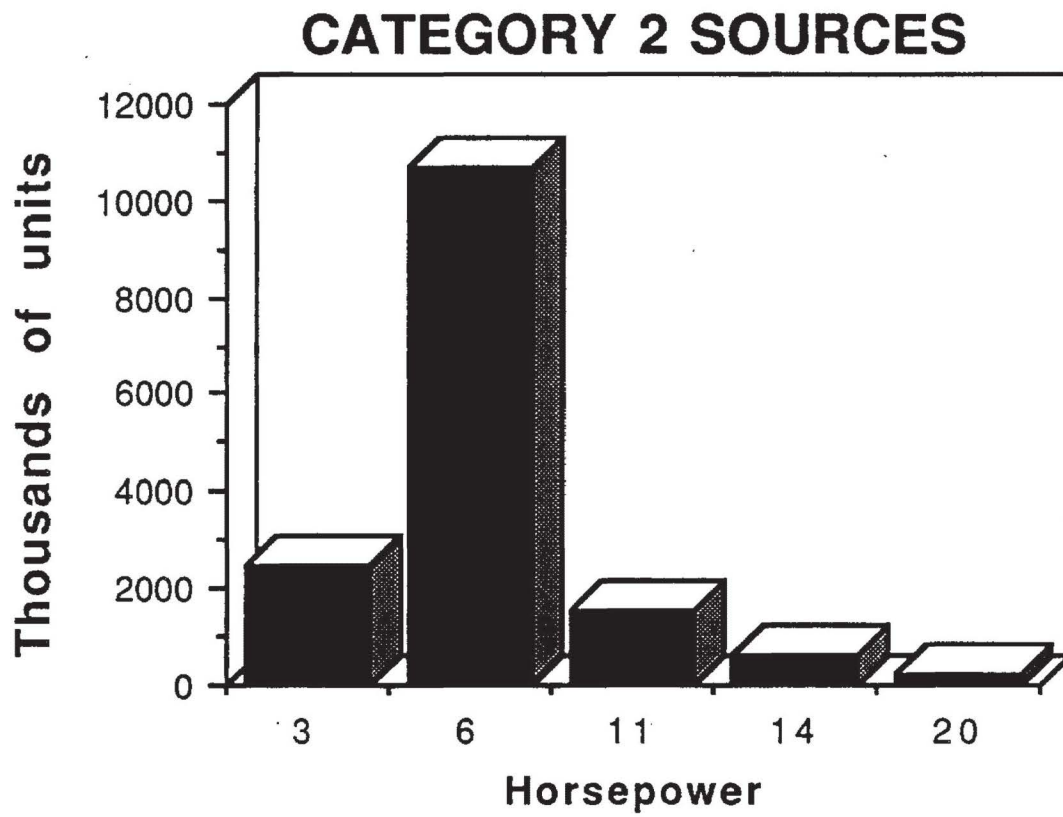

Figure 4



CATEGORY 2 SOURCES - UTILITY EQUIPMENT

Item	Make	Model	Engine type (2, 4, D)	Fuel (G, D, M)	No. of cylinders	# of units in CA	Exhaust por Description	Location	Comments	Priority
a. 1-3 hp										
1. lawn mower	Sears	20	4	G	1	500,000	tube	side		2
2. chainsaw	Poulan	2000	2	G	1	200,000	grill	side		6
3. leaf blower	Snapper	415 BPB	2	G	1	100,000	tube	side		7
4. string trim	Weed eater	XR 30	2	G	1	400,000	grill	side		3
5. edger	Brazilia	2300	4	G	1	300,000	tube	side		4
b. 3.1-5 hp										
1. chainsaw	Homelite	245	2	G		240,000	grill	side		5
2. push mower	Wizard	20	4	G	1	2,000,000	tube	side		1
	Lawn- Chief	20	4	G	1		tube	side		
3. rototiller	Westpoint	JR-5	4	G	1	100,000	tube	side		8
c. 5.1-10 hp										
1. rototiller	Wards	TR	4	G	1	80,000	tube	side		9
d. 10-15 hp										
1. riding mower	Lawn-	12-39F	4	G	1	40,000	tube	under		10
e. 15.1-20 hp										
1. garden tractor	alt					5,000				

Figure 5 - Category 2 Sources

10

4. loader, wheel, 2.5+ yd	John Deere	544	4	D	6	3,200	tube	top		
5. loader, track 20-89 hp	Cat Cavatol	DG-Trax-	4	D	6C+6	2,600	tube	tup-up		
6. loader, track 90+ hp						2,000				
7. tractor, track 20-89 hp						2,600				
8. tractor, track 90+ hp						2,000				
9. motor grader						3,000				
10. compactor						4,000				
11. crane						200				
12. scrapper						1,500				
13. excavator						1,000				
14. log skidder						1,000				
15. paver						1,000				

Figure 6 - Category 3 Sources

CATEGORY 3 SOURCES - HEAVY DUTY EQUIPMENT

Item	Make	Model	Engine type (2, 4, D)	Fuel (G, D, M)	No. of cylinders	# of units in CA	Exhaust por Description	Location	Comments	Priority
a. FARM										
1. tractor 20-99hp	Ford	9N	4	G	4	60,000	tube	under		1
2. tractor 99+ hp	IHC	656	4D	D	6	14,500	tube	top-up		3
3. track tractor 20-98 hp	Cat	D6-9V	4D	D	6	2,500	tube	top-up		
4. track tractor 90+ hp	Cat	D6-C	4D	D	6	6,000	tube	top-up		4
5. combine	John Deere	7720	4D	D	6	5,000	tube	top-up		5
6. windrower	New Holland	1112	4	G	6	5,000	tube	top-up		6
7. cotton picker	alt					5,000				
8. forage harvester						600				
9. track loader 20-98 hp						700				
10. skid steer	New Holland	L-555	4	D	4	2,500	tube	back		
b. NON FARM										
1. tractor, industrial						30,000				2
2. ditcher and trencher	Davis	30+4	4	G	4	4,000	tube	under		7
3. loader, wheel, 2,4 yd						3,500				

Figure 7 - Category 3 Sources, Continued

Figure 8

COMPARISON OF 1978 AND 1988 FARM EQUIPMENT POPULATIONS

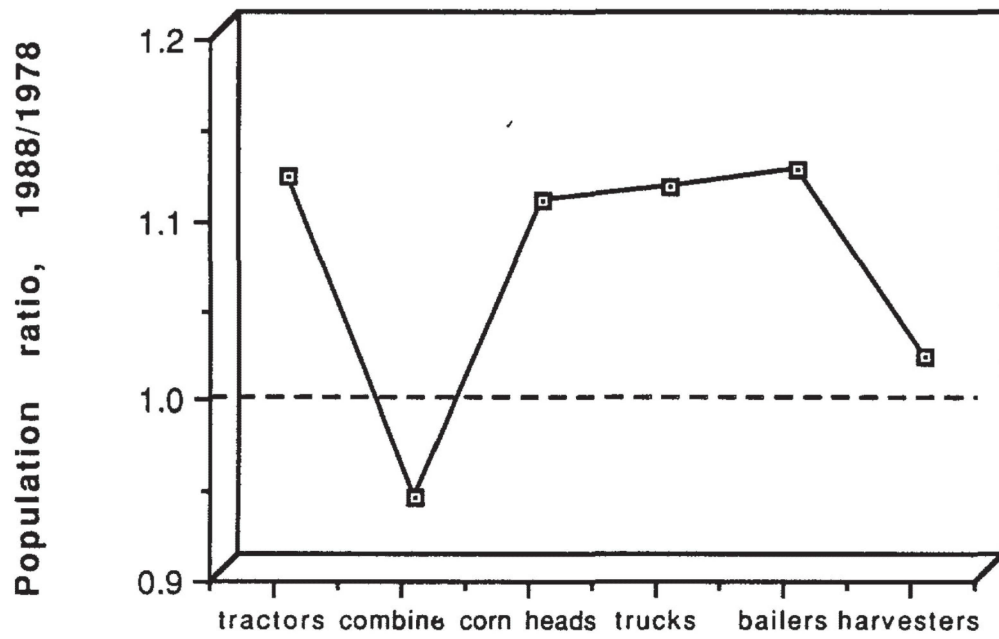

Source : *Implement and Tractor*, October 1988

Table 3 - Category 3 Sample Selection

Item	no. of samples	Priority
Farm Tractor, 20-99 hp	2	1
Farm Tractor, 99+ hp	2	2
Farm Track Tractor, 90+hp	1	3
Combine	1	4
Windrower	1	5
Ditcher / Trencher	1	6
		8

C. Sampling Methodology

1. Sampling Tunnel Design

The sampling method selected for this work evolved according to the path illustrated in Figure 9. The classical approach to sampling vehicle emissions is to use a constant volume sampling (CVS) system, in conjunction with a chassis dynamometer. The engine is typically operated at a variety of speeds, as with the Federal Test Program, and all exhaust is led into a dilution tunnel. Diluted exhaust is pulled through the tunnel at 650 CFM. Baugh³ used this method to sample aldehydes in automobile exhaust (Figure 10). For the types of engines to be tested in this project, the CVS system was too cumbersome to be practical. The CVS system is essentially a variable-dilution system, necessitated by the fact that the test engine is operated at a variety of speeds. An alternative to the CVS test method would involve operating the engine at constant load (hence, constant emissions), and using a constant (or no) dilution factor. The sampling system would have to incorporate probes for both hydrocarbon and aldehyde samples. The analytical requirements for these two classes of compounds demanded separate sampling trains. With simplicity and portability as important factors, the sampling system illustrated in Figure 11 was considered. It was based on a minor modification of a Sun MGA-90 analyzer (Figure 12). Complications arising from the analysis of the water separator contents ultimately lead to the rejection of this design.

The fabrication and operation of a dilution mini-tunnel was described by MacDonald⁴ (see Figure 13). From this project's point of view, the tunnel had several advantages over other designs. It was small enough to be portable (less than 6 feet overall), and required no pump to pull diluted exhaust through it. These were important characteristics, since the testing apparatus may need to be transported to where the test engines were located. The modification of MacDonald's design used in this project is shown in Figure 14. The dilution nozzle was machined from a solid block of aluminum, and turned to provide a shoulder for attachment of upstream and downstream portions of the tunnel. These sections sealed with an O-ring into the nozzle section, and could be easily removed for cleaning or transportation. Instead of having the exhaust pulled through the system with a vacuum pump (as with CVS), this mini-tunnel used a pressurized zero air source upstream of the nozzle. Nozzle dimensions were selected that allowed sonic flow through the throat. The low pressure in the nozzle throat "pulled" exhaust into the tunnel. In the original reference, Mac Donald verified the absence of stratification with this design. A series of wall-to-wall traverses revealed essentially no variation in sampled CO₂ concentrations in the tunnel. Unlike the CVS system, only a portion of the total engine exhaust was led into the tunnel. Since the volume of exhaust handled was comparatively low, comparably low volumes of dilution air were needed to produce a 10:1 dilution. Thus, zero air from a compressed gas cylinder was used as a source of dilution air. During operation, a back pressure valve was adjusted to maintain a slight positive (about 1 inch of water) pressure at the downstream end of the tunnel. This prevented outside air from entering the tunnel through any small leaks that may have been present. Diluted exhaust leaving the tunnel was led away from the test engine by a flexible duct to prevent its re-combustion by the engine. The CO₂ content of the raw and diluted exhaust was determined by a Sun MGA-90 NDIR analyzer.

Figure 9

POSSIBLE SAMPLING METHODS FOR HC AND RCHO

- **CVS**
- **NO DILUTION**
- **MINI-DILUTION**
- **MODIFIED MINI-DILUTION**

Figure 10 - CVS Sampling Scheme

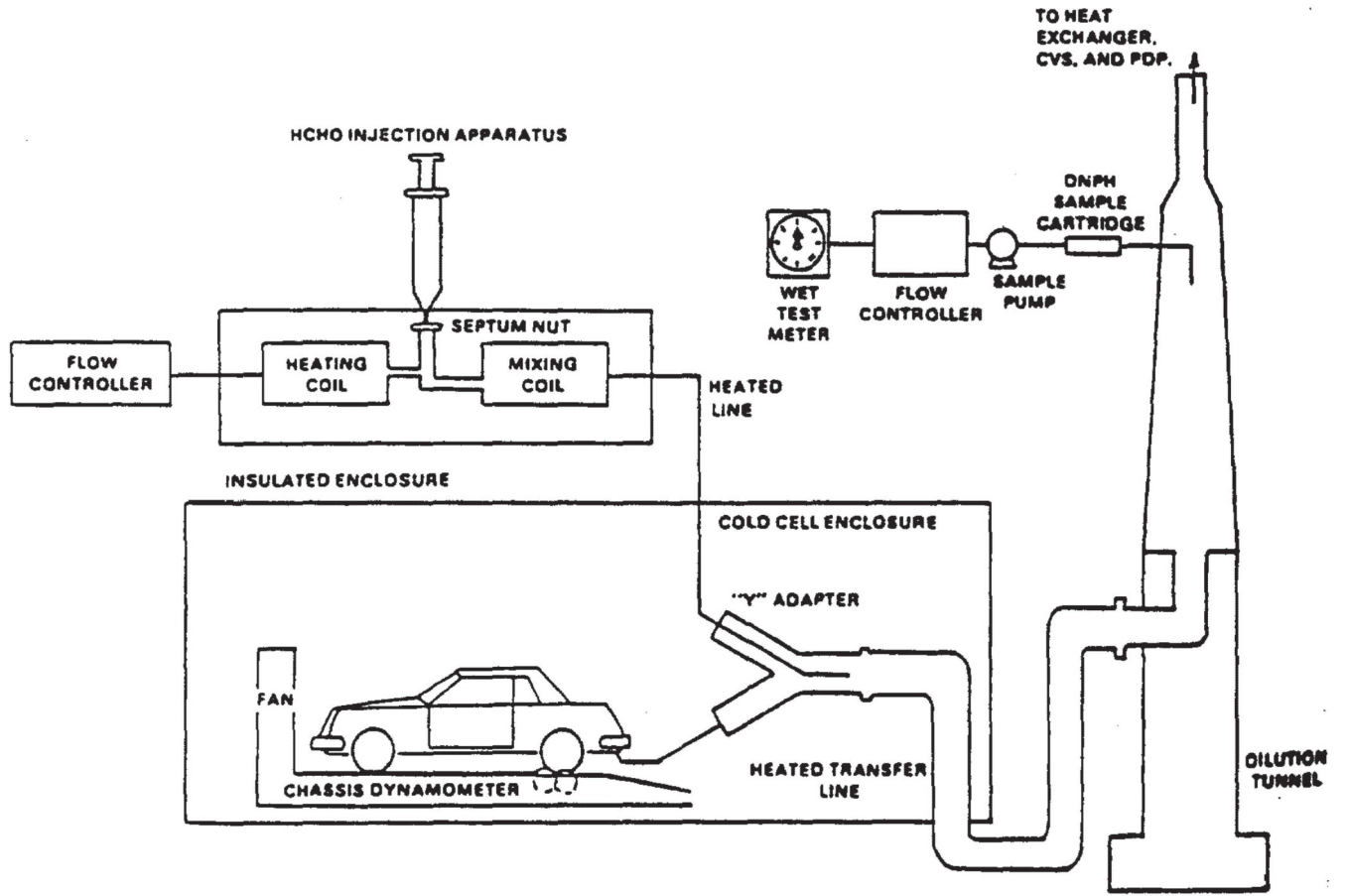

Test cell configuration.

EXHAUST SAMPLING

NO DILUTION

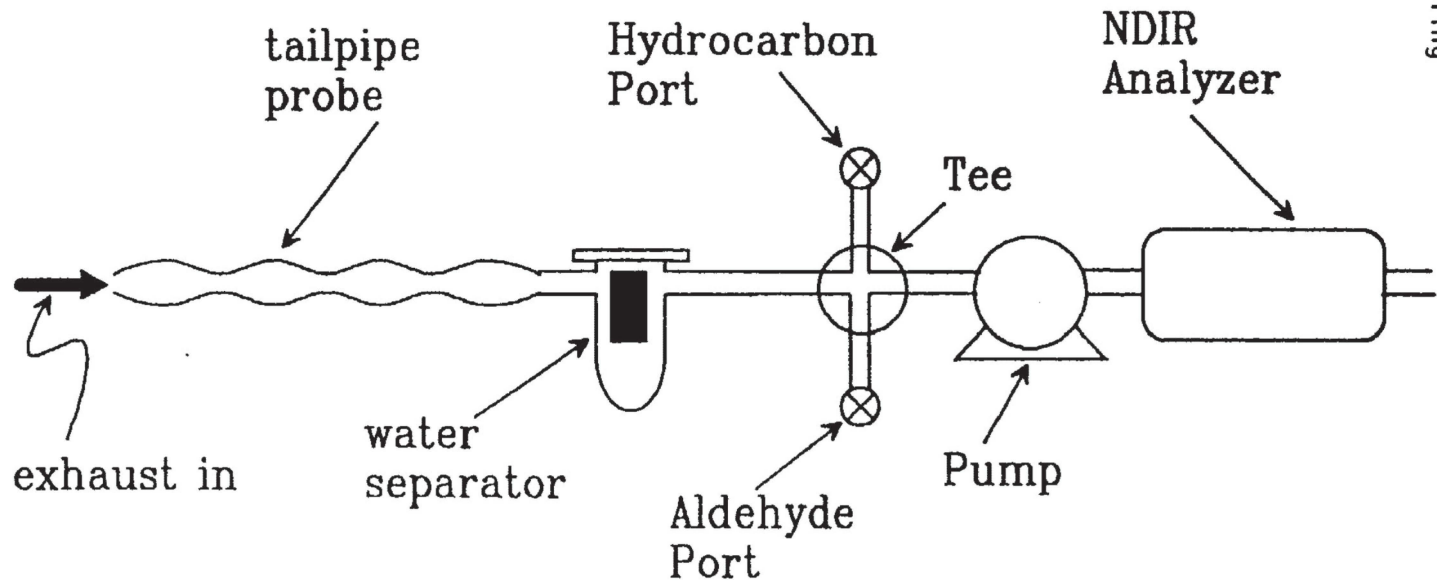

Figure 11 - No Dilution Sampling

FIGURE 18- SUN MGA-90 ANALYZER

INFRA-RED EXHAUST PERFORMANCE ANALYZER

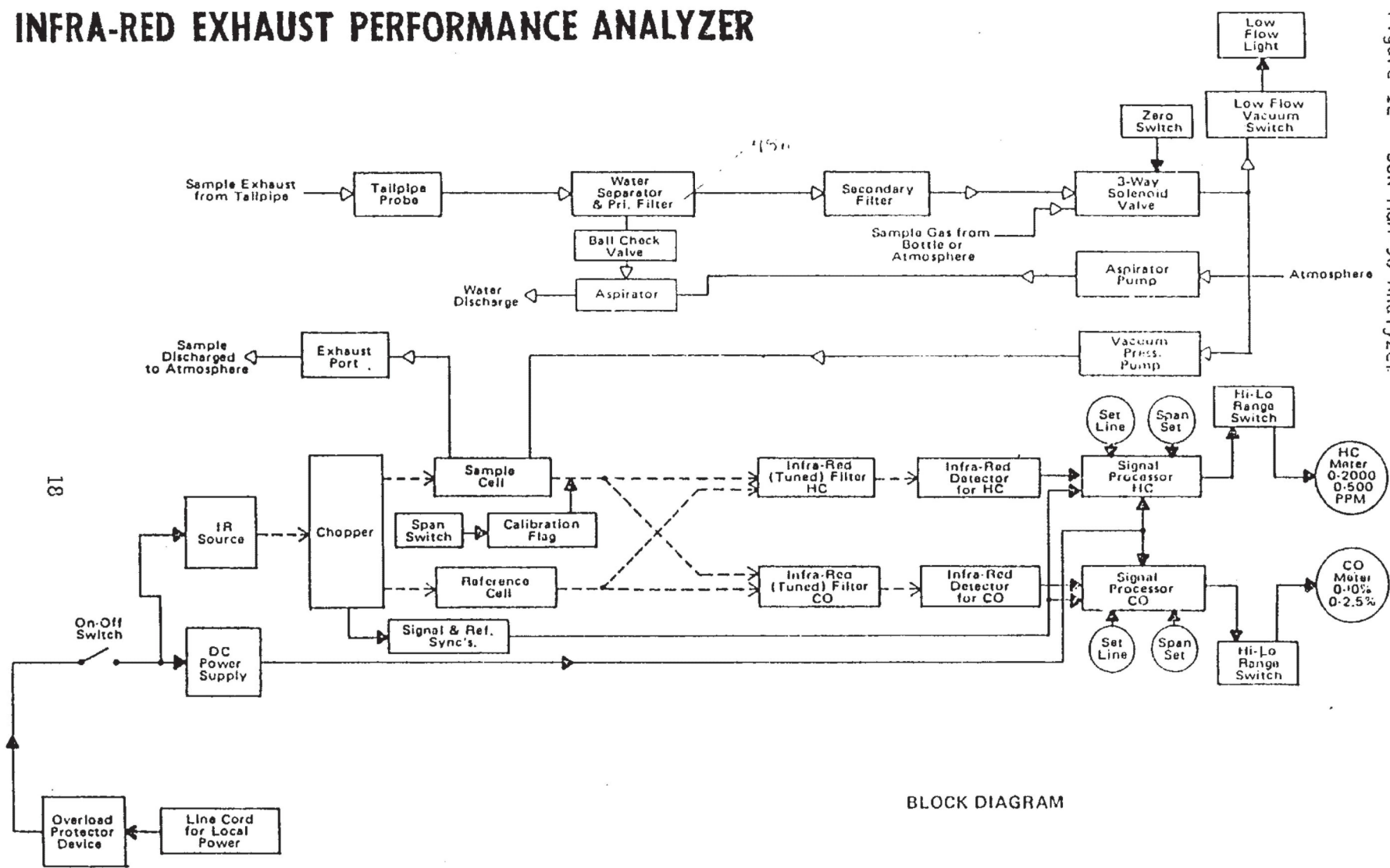

Figure 12 - SUN MGA-90 Analyzer

BLOCK DIAGRAM

—▷ PNEUMATIC
 —▷ ELECTRICAL
 - - -▷ OPTICAL

SUN ELECTRIC CORPORATION
 MGA-90

FIGURE 13- LITERATURE DILUTION TUNNEL

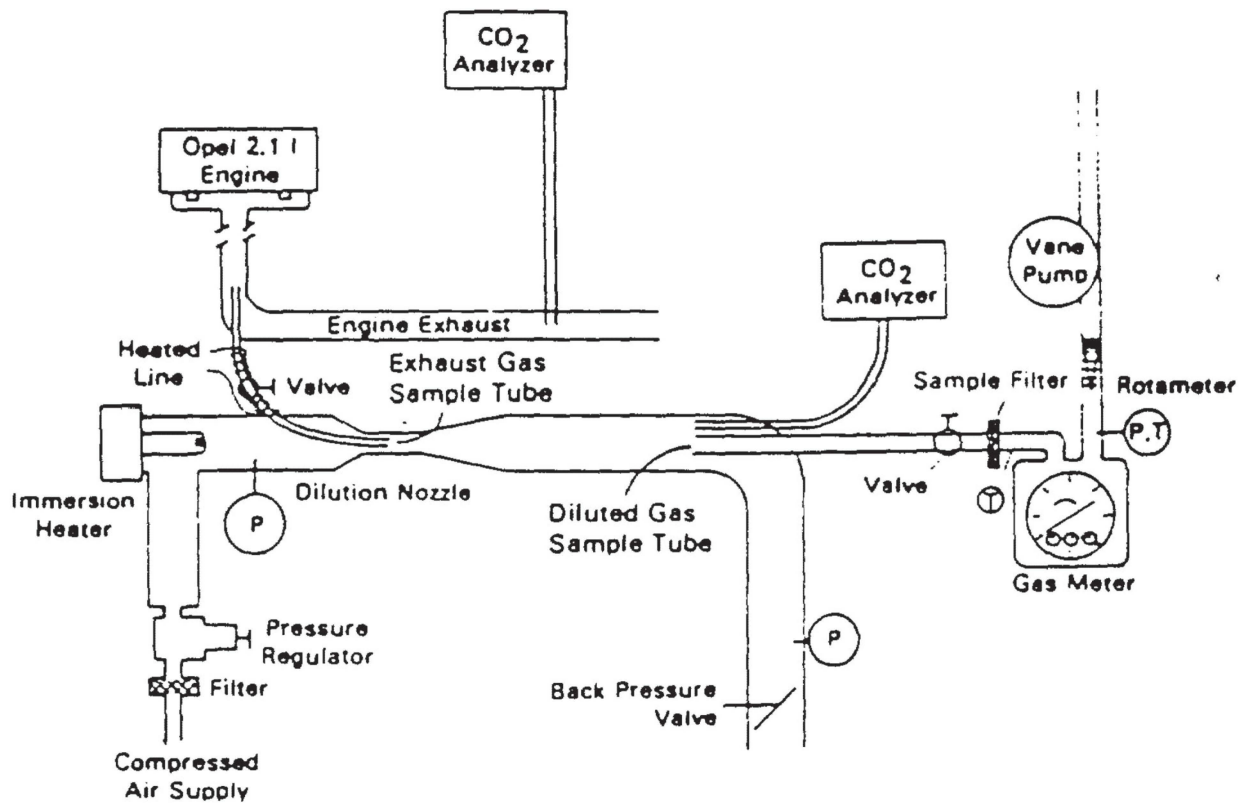

800185

Experimental Measurements
of the Independent Effects
of Dilution Ratio and Filter
Temperature on Diesel
Exhaust Particulate Samples

J. Scott MacDonald and Steven L. Ploe
Engine Research Dept.
General Motors Research Laboratories
Warren, MI

James B. D'Arcy and Richard M. Schreck
Biomedical Science Dept.
General Motors Research Laboratories
Warren, MI

FIGURE 14- PROPOSED DILUTION TUNNEL

EXHAUST SAMPLING MINI - DILUTION

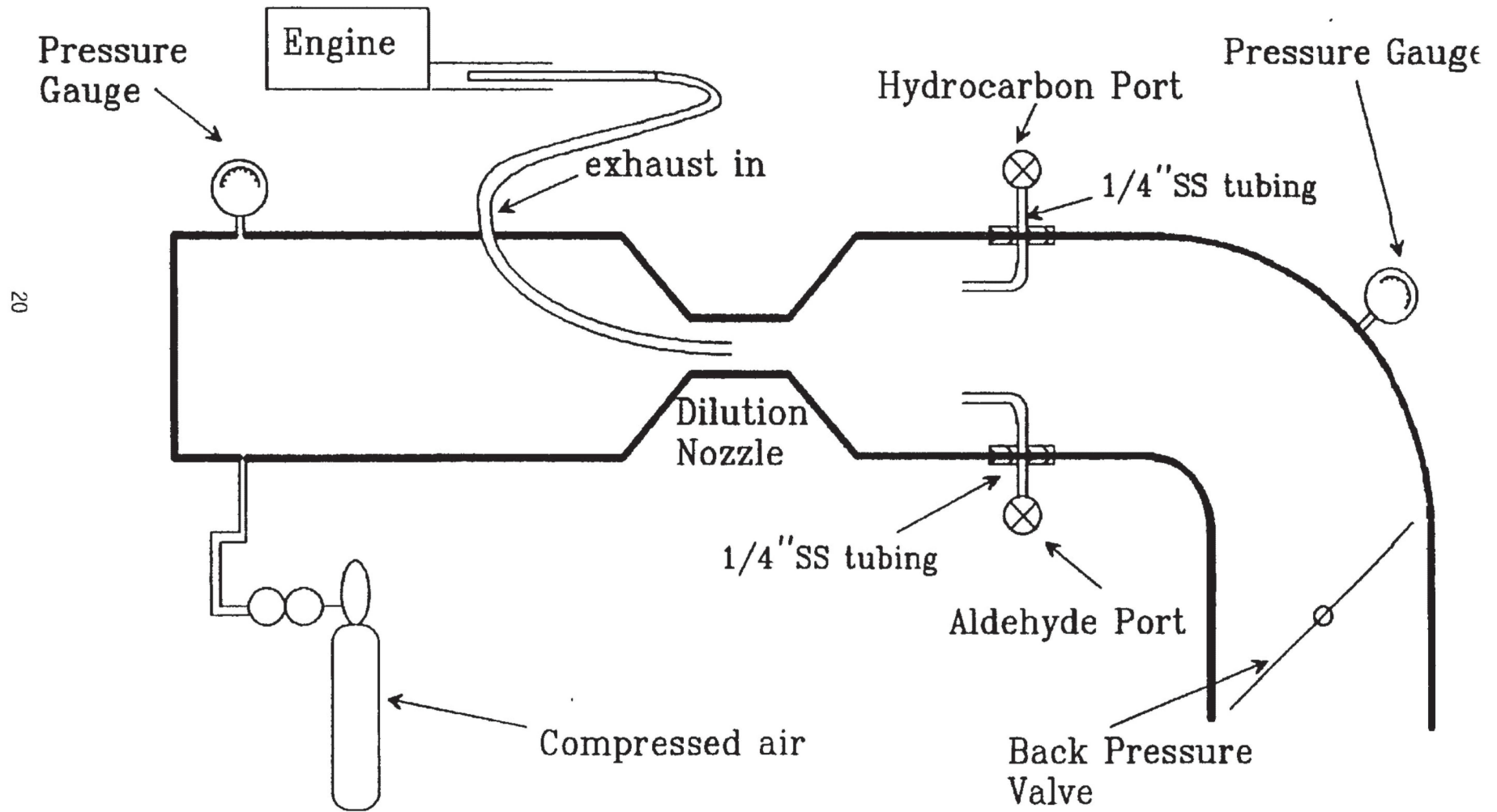

The final configuration of the dilution tunnel was developed. Figure 15 shows construction details. The first operational test of the tunnel was performed using a small gasoline powered engine. Hydrocarbon CO₂ concentrations were measured in raw exhaust with a Sun MGA NDIR analyzer. For this initial test run, the tunnel was operated with nitrogen gas, and nitrogen-diluted exhaust was measured at the tunnel outlet with the same analyzer. For all other tests, ultra zero air was used. For widely varying inlet pressures, the tunnel dilution ratio of roughly 10:1 was remarkably constant. This is in agreement with MacDonald's work, which formed the basis for the tunnel. Once successful operation of the tunnel had been demonstrated, attention was turned to the trains for hydrocarbons and aldehyde sampling. The chief concern was that both trains would operate concurrently. The problem of flow regulation into the stainless steel canister used for hydrocarbon sampling was solved by using a hypodermic needle as a limiting orifice. A canister fill time of about 12-15 minutes was attained with a 26 gauge needle. This time was selected to match the minimum sampling time required by the aldehyde sampling train. Representative sampling setups are illustrated in Appendix C.

2. Sampling for Hydrocarbons in Exhaust

The sampling train to be used for sampling hydrocarbons from the diluted exhaust stream in the tunnel is shown in Figure 16. It utilizes the same type of evacuated, passivated 3.2 liter stainless steel canisters described earlier. Once steady-state had been reached in the tunnel, the valve on the canister was opened. Sample entered the canister at a rate dependent on the critical orifice used. The orifice size was selected to allow sampling times close to those of the aldehyde train (vide infra) which operated concurrently. The cylinder valve was closed just before cylinder pressure reached atmospheric pressure. Final cylinder pressure was recorded, and verified at the analytical laboratory immediately prior to analysis.

3. Sampling for Aldehydes

Since aldehydes represent a class of reactive organic compounds, the sampling methodology must take that fact into consideration. Effective aldehyde sampling methods have become available in recent years^{5,6}. These methods use the reactivity of aldehydes as the basis for sample collection. Stable aldehyde derivatives may be prepared by reaction with 2,4-dinitrophenylhydrazine (DNPH), as shown in Figure 17. Early research into using this reaction involved solutions of DNPH in midget impingers. Variations on this theme led to the development of DNPH-impregnated solvent tubes. Presently, disposable cartridges containing DNPH-coated Florisil are commercially available. Initially, the use of DNPH-impregnated sorbent tubes was explored for aldehyde sampling in exhaust streams. Uncertainties about concentration limits and break-through ultimately led to the selection of midget impingers for aldehyde sampling. A modification of EPA's method TO5 has been shown to be effective in this use. While not the most convenient of the aldehyde sampling methods, it has been shown⁷ to be free from interferences. The dinitrophenylhydrazine, DNPH (Matheson), was purified by double re-crystallization from hot acetonitrile. Small batches of DNPH absorber solution were prepared at once, to minimize potential contamination. The working solution (125 mg DNPH / 250 mL acetonitrile) was stored at 0 ° C in a glass bottle kept inside a friction topped metal canister partially filled with activated charcoal. Just prior to sampling, the impingers were filled with a measured volume (10 mL) of the absorbing solution, and 150 microliters of ultrapure concentrated hydrochloric acid were added. This technique has been shown⁸ to be effective in maintaining the purity of the absorbing solution.

The final design of this sampling train is shown in Figure 18. Flow through the train was controlled by a 22 gauge hypodermic needle acting as a critical orifice. Flow through the train ca. 500 mL/minute) was measured with an electronic soap bubble flowmeter (MINI-BUCK M5), traceable to NIST. After sampling, the impinger contents were transferred to 40 mL Teflon-faced screw capped vials, and kept at 0° C until ready for analysis. Detailed protocols for sampling engine exhaust will be found in Appendix D.

Figure 15 - Tunnel Construction Details

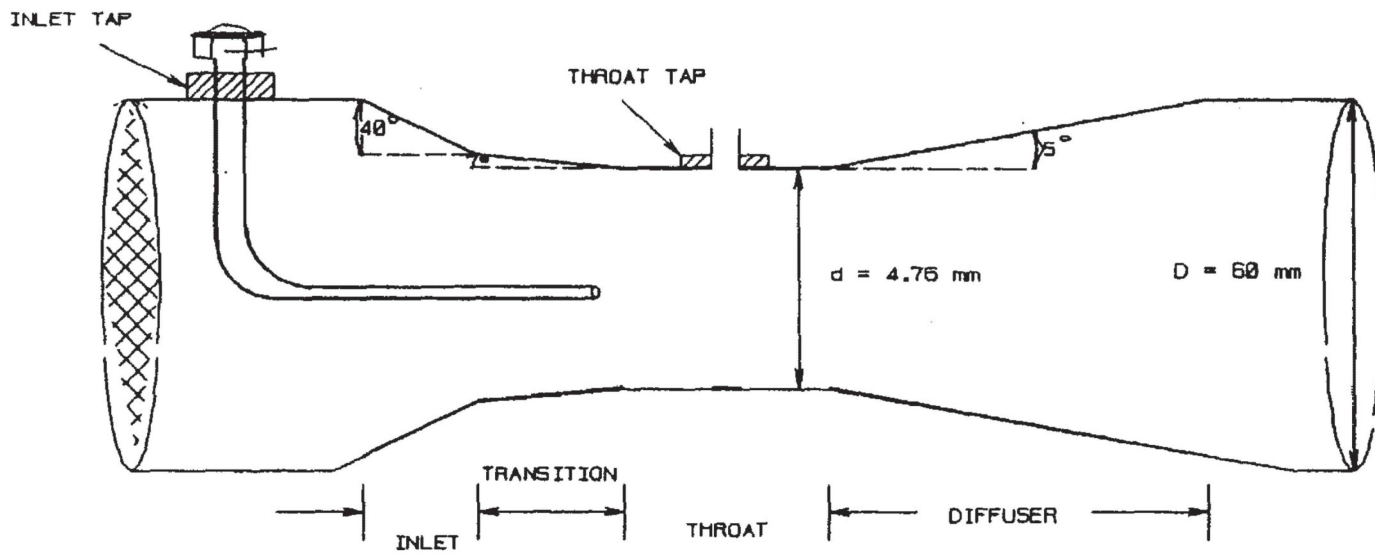
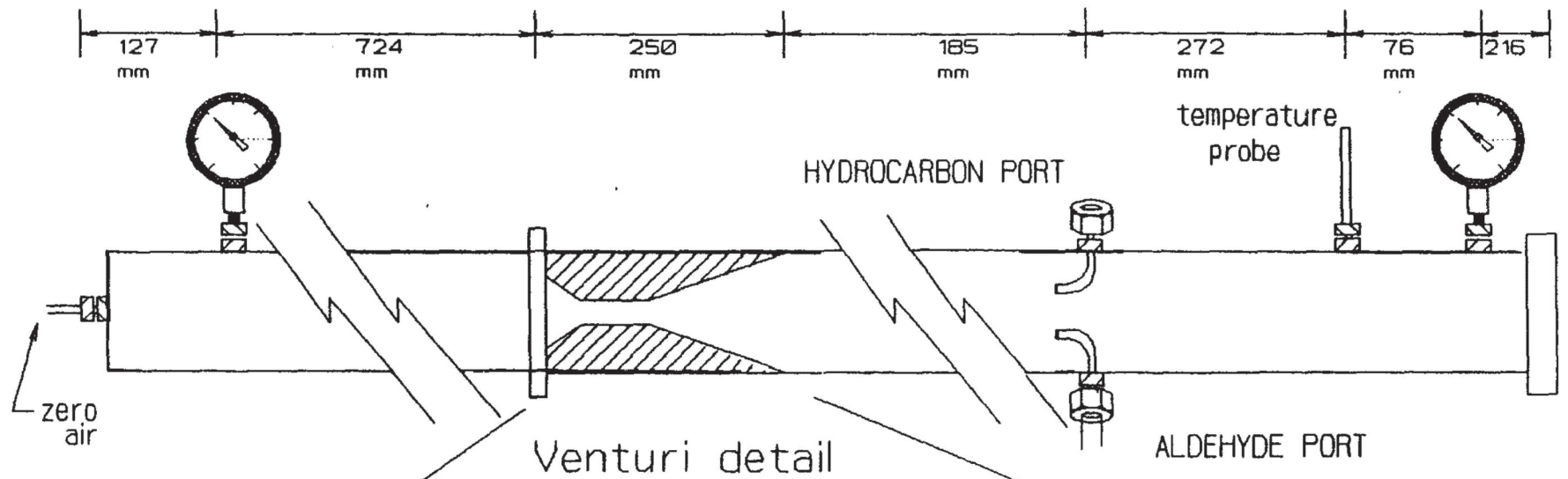

Figure 16

HYDROCARBON SAMPLING TRAIN

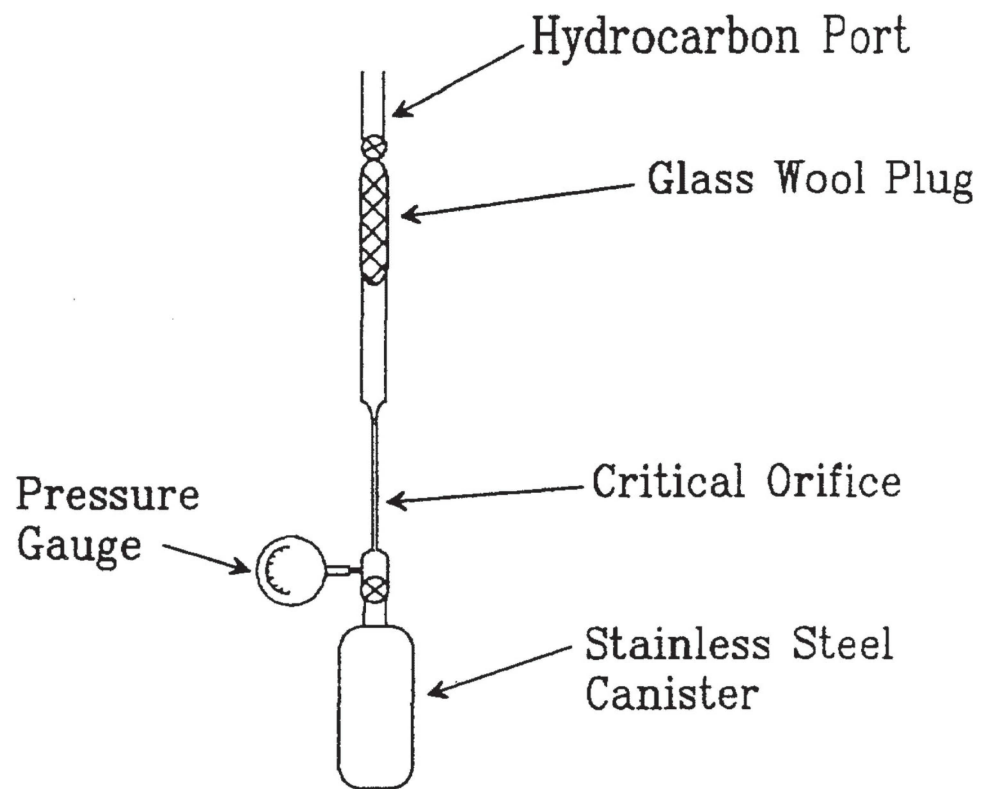
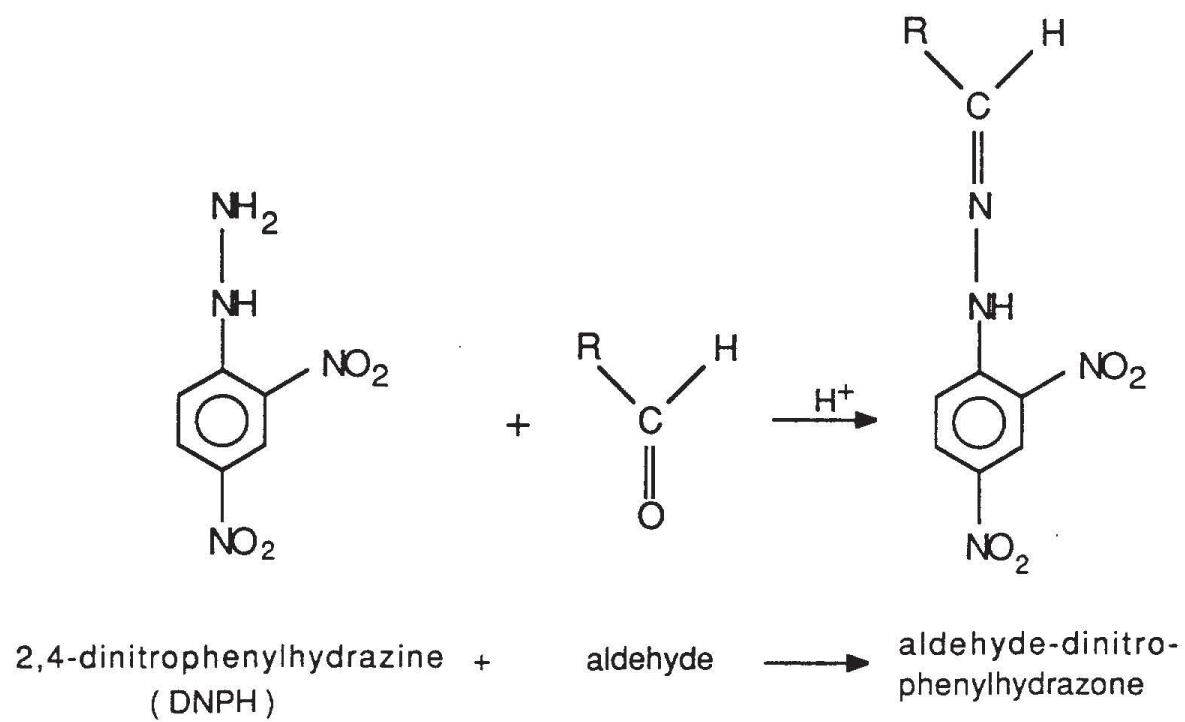

Figure 17

DERIVATIZATION OF ALDEHYDES



ALDEHYDE SAMPLING TRAIN

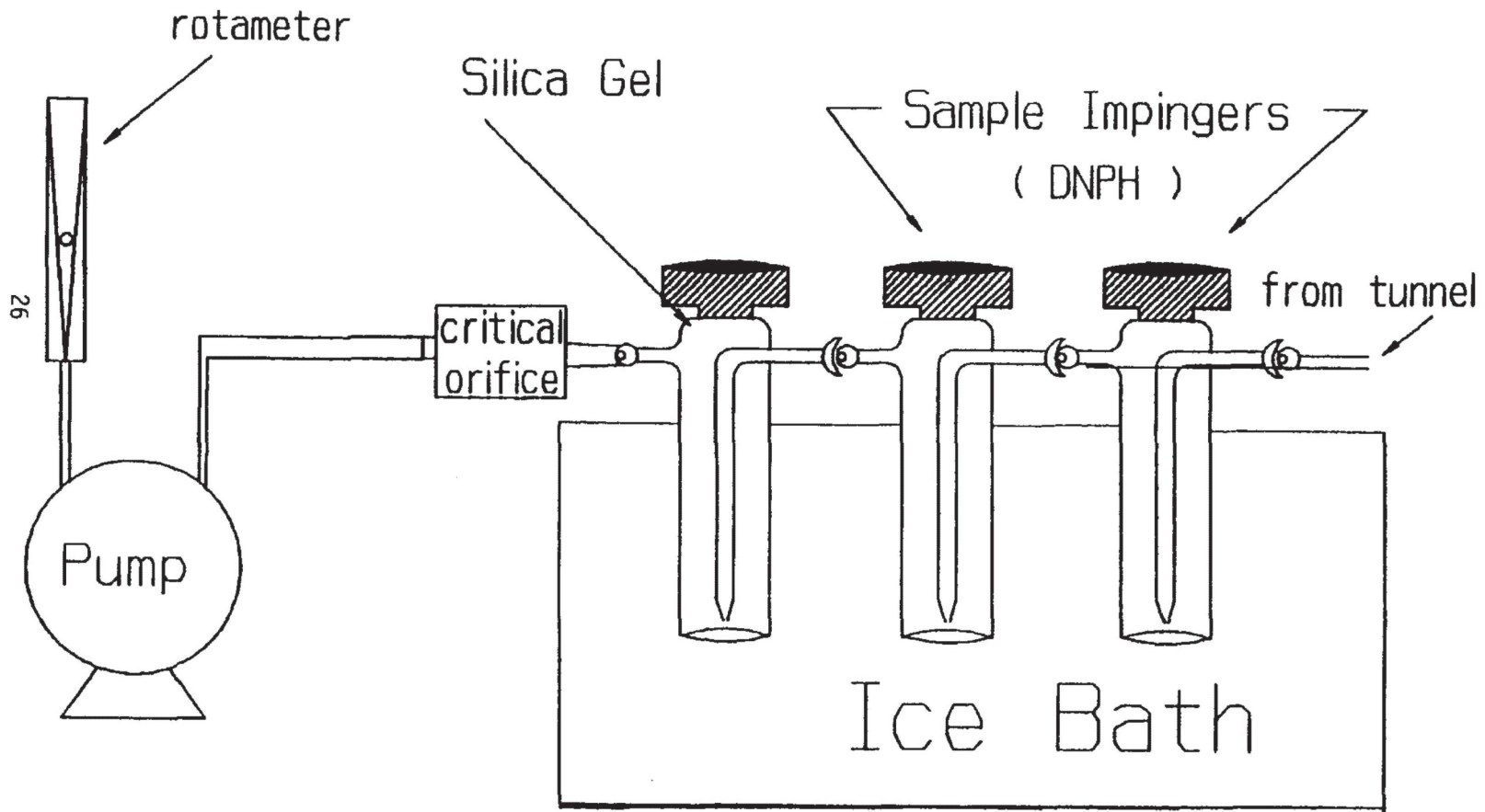

Figure 18 - Aldehyde Sampling Train

4. Sampling for High Molecular Weight Hydrocarbons

Organics having carbon numbers in the range of C10-C20 were sampled by adsorption onto cartridges filled with XAD-2 resin. The final design of these cartridges is shown in Figure 19. The cartridge body was fabricated by ring-sealing a short length of 10 mm glass tubing inside 0.5 inch Pyrex tubing. A circular stainless steel screen was positioned to rest against the 10 mm tubing. A plug of Pyrex wool was pushed against the screen to act as a bed support for the XAD-2 resin. For connection to the tunnel, glass-filled polyethylene compression fittings (Cole Parmer N-6465-65, N-6387-62) were used. A photograph of the assembled cartridge will be found at the end of Appendix B. For sampling Diesel engine exhaust, a stainless steel tee was placed onto the aldehyde sampling port of the dilution tunnel. A critical orifice attached to a pump was used to regulate flow to about 500 mL/minute. Sample collection was concurrent with hydrocarbon and aldehyde samples. After sampling, both ends of the cartridge were capped with hexane-rinsed aluminum foil. The entire cartridge was then wrapped with foil, and kept in an ice chest at 0° C until transported to the laboratory for analysis.

D. Quality Assurance

Quality assurance (QA) activities for Category 2 and 3 sources may be divided into three categories:

1. Pre-field sampling QA
2. Field sampling QA
3. Analytical QA

Pre-field activities included a complete checkout of all components in the sampling system. Data on the analysis of gas cylinders to be used was compiled and stored. Data forms, sample labels and containers were located and prepared. The Sun NDIR analyzer was calibrated according to the methods recommended by the manufacturer. Prior to actual use, the dilution tunnel was set up, and flushed with zero air. This purge air was simultaneously drawn through the hydrocarbon and aldehyde sampling trains and analyzed. Analysis of these blanks provide confirmation of the absence of background contamination. Prior to sample collection, all sample lines were thoroughly flushed with zero air. After each sample was taken, the exhaust transfer line was backflushed, and the tunnel was dismantled, inspected and cleaned. Adherence to the written protocols found in Appendix D enhanced the overall reliability and reproducibility of data obtained. Quality assurance activities pertaining to analyses are described in Appendix E.

E. Analytical Methodologies

A variety of analytical techniques were needed to quantitate the hydrocarbon species present in the engine exhaust samples. The following section summarizes the analytical methodologies used by the Project Subcontractor, Environmental Analytical Service, Inc. (EAS). Details and standard operating procedures for the methods of analysis will be found in Appendix E.

Methane was analyzed using a molecular sieve 5A column, operated isothermally at 50 ° C. Light hydrocarbons were separated using a ten foot column packed with phenylisocyanate on 80/100 mesh Durapack. Samples with high hydrocarbon content were analyzed on a 30

foot column containing 23 % SP-1700 on 80/100 mesh Chromosorb PAW. Heavy hydrocarbons were analyzed using a 100 meter fused silica capillary column.

Comparison of the light (packed column) and heavy hydrocarbon (capillary column) runs could be made using a number of peaks in the C2 to C4 range. The heavy stationary phase loading of the 100 meter capillary column allowed for the separation of the lighter hydrocarbons. Initially, values for the light hydrocarbons (from C2 on) obtained from the integrator output of the capillary column run were used for calculations. A review of the results so obtained indicated some inconsistencies in the light hydrocarbon concentrations of some samples. When the chromatograms were examined in detail, there was some ambiguity assigned with ethane, ethylene and acetylene peaks, due to insufficient resolution of these components for these samples. Values for all engine samples in this report were re-calculated using concentration information obtained from the packed column light hydrocarbon runs for ethane, ethylene and acetylene.

The method used for analysis of aldehydes was a modification to EPA method TOS⁹, which is functionally similar to CARB method 110¹⁰. The sampling method was based on the reaction of DNPH in acidified acetonitrile with aldehydes and ketones to form stable hydrazone derivatives. For analysis, an aliquot of the impinger contents was injected onto a Supelcosil LC18 reverse phase column. The system was run isocratically, using a mobile phase consisting of 70 % acetonitrile and 30 % water. The aldehyde derivatives were detected by a UV-Visible detector operating at 360 nm, and quantitated on an HP 3393A computing integrator. Details of the analyses may be found in Appendix E.

Since the carbon number limitation for the SUMMA canisters is C10 or C11, an additional sampling train was used to retain higher molecular weight hydrocarbons in the C10 to C20 range. A glass cartridge, filled with XAD-2 resin was used for this purpose. The XAD-2 resin is the material recommended by the California Air Resources Board (CARB) for source sampling of semi-volatile organic compounds. The procedures used for extraction and analysis of the cartridges are described in CARB Method 429 "Determination of Polycyclic Aromatic Hydrocarbon Emissions from Stationary Sources".

Figure 19

XAD CARTRIDGE DESIGN

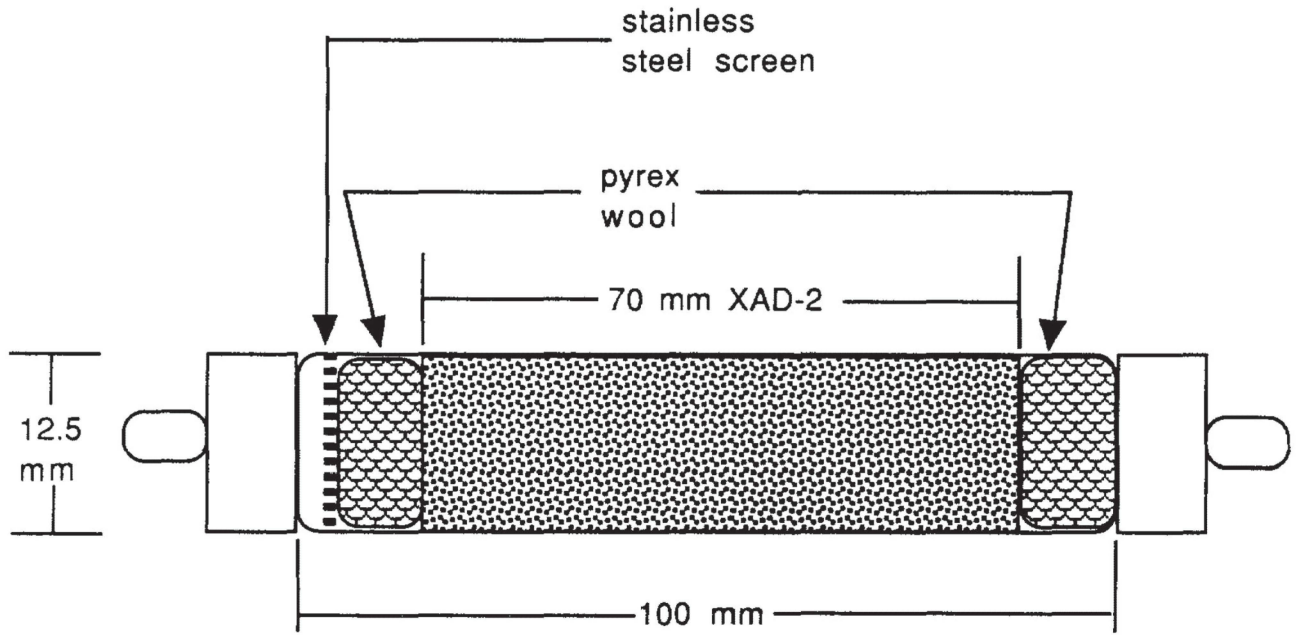

F. Engine Sampling

Using the dilution tunnel described previously, 21 engine tests were performed. Table 4 shows the engines tested and the corresponding analytical samples taken. Volatile hydrocarbon and aldehyde samples were taken for all engines. Hydrocarbon samples were collected in evacuated, SUMMA polished stainless steel canisters. Aldehydes were collected in midget impingers, filled with DNPH-acetonitrile, using the methodology described previously. Semi-volatile hydrocarbons from the last 8 tests were collected on XAD-2 cartridges, as outlined earlier. Selected sampling setups are shown in Appendix C. All sub-systems used for the tests functioned perfectly, and 100% of samples were successfully obtained.

All engines were tested "as received", with no special tuning, and were thus typical of "in-use" condition. Exhaust samples were taken under conditions that classify them as "spot" samples. Engines were warmed up prior to sampling, then maintained at full throttle or rated speed for the duration of the test (typically about 20 minutes). Utility engines were fueled immediately prior to sampling, to ensure sufficient fuel to complete the test without interruption. Mixtures for 2 stroke engines were blended immediately before fueling the engines. Manufacturer recommendations were followed for fuel mixtures. Two stroke engines corresponding to samples ET-1, 3 and 4 used a 25:1, while ET-9 used a 32:1 ratio. Fuel (EXXON unleaded gasoline, temp 80, grav. 58.0, octane 87; ARCO diesel fuel, DSL-LS) for all engines was from the Cal Poly motor pool.

TABLE 4 ENGINE TESTS

ID #	item	MFGR.	Engine		Sample types taken*	temperature, °C		test speed, RPM	test load
			type	size		ambient	tunnel		
ET-1	lawnmower	Snapper	2 stroke	3 HP	1, 2	20	24	5000	blade
2	lawnmower	Snapper	gas	5 HP	1, 2	21	25	3000	blade
3	chainsaw	Sears	2 stroke	2 HP	1, 2	20	21	6500	12' bar / chain
4	trimmer	Snapper	2 stroke	3 HP	1, 2	20	28	3000	string head
5	lawnmower	Sears	gas	3 HP	1, 2	20	27	3350	blade
6	edger	McLane	gas	2 HP	1, 2	26	28	3600	cutting blade
8	chainsaw	Husqvarna	gas	10 HP	1, 2	26	28	6500	cutting chain
9	blower	Toro	2 stroke	1.5 HP	1, 2	26	29	7000	blower
10	lawnmower	Swirl Magic	gas	3 HP	1, 2	20	23	3150	blade
11	lawnmower	Swirl Magic	gas	3 HP	1, 2	20	23	3200	blade
12	rototiller	Montg. Ward	gas	5 HP	1, 2	22	26	3800	blades,high gear
13	riding mower	Lawn Chief	gas	12 HP	1, 2	23	24	3000	blade
15	rototiller	Sears	gas	8 HP	1, 2	25	27	3700	tiller wheel
17	tractor	Ford	diesel	130 HP	1, 2, 3	30	32	1800	none
18	tractor	Ford	diesel	130 HP	1, 2, 3	22	23	1800	none
20	combine	John Deere	diesel	165 HP	1, 2, 3	24	28	1800	none
21	swather	Sperry New-Holland	diesel	43 HP	1, 2, 3	24	27	1850	none
23	tractor	Case	diesel	43 HP	1, 2, 3	28	33	2200	none
25	tractor	John Deere	diesel	33.4 HP	1, 2, 3	21	24	2400	none
26	tractor	Caterpillar	diesel	105 HP	1, 2, 3	31	36	1800	none
27	tractor	John Deere	diesel	150 HP	1, 2, 3	15	18	1800	none

* Sample types:

1 = hydrocarbon (canister)

2 = aldehyde (impinger)

3 = XAD

G. Format for Results

The engine exhaust samples contained aldehydes and ketones, in addition to saturated, unsaturated and aromatic hydrocarbons. In order to express exhaust composition on a percentage basis, an estimate of the "total hydrocarbon content" must be made. Previous investigators have ignored the (usually small) contribution of aldehydes to the total hydrocarbon content determined by GC-FID. Formaldehyde, usually the largest component of the exhaust aldehydes, gives essentially no response to the FID. Consequently, using the total FID area plus methane as the total hydrocarbon value underestimates the true total. We have elected to include all aldehyde values in the total. Although this may *slightly* overestimate the total hydrocarbon content of the samples, it should be closer to the true value than if all aldehydes were neglected. A consequence of this assignment is that all percentages will sum to exactly 100 %.

As with the oil field samples, GC-MS runs were obtained for all exhaust samples, primarily to aid in compound identification. The total ion chromatograms from these runs revealed between 20 and 90 integratable peaks - significantly fewer than the FID runs, but covering a higher range of boiling points. The mass spectra from these peaks were searched against the NBS Revision E Library, using search software provided by Hewlett Packard for use with the mass selective detector. In a few instances, compounds not seen in the FID run were identified by the mass spectra. Naphthalene is an example of such an occurrence. These GC-MS compounds were quantitated, and added into the "total hydrocarbon" count.

Analysis of extracts from the XAD-2 resin samples showed no compounds present above the detection limit of about 2 micrograms per sample.

H. Results

1. Aldehyde Analysis Results

Results for aldehyde analyses of impinger contents have been incorporated into the overall hydrocarbon analyses. In some of the aldehyde samples, chromatographic peaks were obtained at retention times that did not correspond to known carbonyl compounds. For these peaks, a carbon number was assigned, based on the relative retention time of known aldehydes. As the carbon number increases, the number of possible aldehyde and ketone isomers rises dramatically. The chromatography should correctly identify the carbon number of the DNPH-derivative, but not necessarily indicate the correct isomer in all cases.

Hydrocarbon speciation information is arranged by test number, as shown in Tables 5 - 25. As with the oil field samples, these data also were organized into a LOTUS 1-2-3 database. The format of the database is actually the transpose of the results shown in the Results Tables. Compound names are column headings (fields), and sample numbers are rows (records). A copy of the database, named ET_SUMRY.WK1, was copied to a 3.5 inch floppy disk, and sent to ARB along with this report.

Table 5 - ET-01 Snapper lawnmower (2 stroke 3 hp)

Compound	% by mass
Methane	1.4829
Ethylene	0.1807
Ethane	0.0875
Acetylene	0.4540
Propene	1.1280
Propane	0.1585
Methylacetylene	0.0000
i-Butane	0.3654
methanol	0.0000
i-butylene	0.5364
1-butene	0.6358
1,3-Butadiene	0.0000
n-Butane	0.1441
trans-2-butene	0.0000
2,2-dimethylpropane	0.0000
cis-2-butene	0.0000
ethanol	0.0000
i-Pentane	4.5419
1-pentene	0.3563
n-Pentane	2.1211
trans-2-pentene	0.8005
cis-2-pentene	1.1799
2,2-Dimethylbutane	1.9795
Cyclopentane	0.8413
2,3-Dimethylbutane	0.0000
2-Methylpentane	3.4758
3-Methylpentane	2.2253
n-Hexane	1.9756
Methylcyclopentane	2.4578
2,4-Dimethylpentane	0.5887
Benzene	4.6134
Cyclohexane	0.0000
2-Methylhexane	1.9790
2,3-Dimethylpentane	0.7093
3-Methylhexane	2.0083
2,2,4-trimethylpentane	0.5988
n-Heptane	1.5458
Methylcyclohexane	0.3333
2,4-Dimethylhexane	0.5638
2,3,4-Trimethylpentane	0.8519
Toluene	15.3360
2,3-Dimethylhexane	0.3799
2-Methylheptane	1.0896
3-Ethylhexane	1.0560
n-Octane	0.8711
Ethylbenzene	3.4988
m-Xylene	9.3262
p-Xylene	0.0000
Styrene	0.8656
o-Xylene	3.7281
n-Nonane	0.5244
i-Propylbenzene	0.0000
n-Propylbenzene	0.4799
3-Ethyltoluene	0.0000

Compound	% by mass
1,3,5-Trimethylbenzene	0.6379
2-Ethyltoluene	0.4570
t-butylbenzene	0.0000
1,2,4-Trimethylbenzene	0.7679
i-butylbenzene	0.0000
s-butylbenzene	0.0000
n-Decane	0.0000
1,2,3-Trimethylbenzene	0.0000
indane	0.0000
1,3-Diethylbenzene	0.0000
1,4-Diethylbenzene	0.0000
n-butylbenzene	0.0000
1,2-Diethylbenzene	0.0000
1,4-dimethyl-2-ethylbenzene	0.0000
1,3-dimethyl-4-ethylbenzene	0.0000
1,2-dimethyl-4-ethylbenzene	0.0000
1,3-dimethyl-2-ethylbenzene	0.0000
n-undecane	0.0000
1,2,3,5-tetramethylbenzene	0.0000
1,2,4,5-tetramethylbenzene	0.0000
OTHER COMPOUNDS	
2-propenylbenzene	0.0000
1,2-dichlorobenzene	0.0000
2-methylstyrene	0.0000
1-ethynyl-4-methylbenzene	0.0000
naphthalene	0.0000
OXYGENATES	
formaldehyde	0.0101
acetaldehyde	0.0473
acetone	0.0203
propanal	0.0144
MEK	0.0128
butanal	0.0113
2&3-pentanone	0.0040
cyclohexanone	0.0026
pentanal	0.0050
4-methyl-2-pentanone	0.0036
2-methyl-3-pentanone	0.0031
hexanal	0.0227
benzaldehyde	0.0165
C4 ketone	0.0107
C6 ketone	0.0000
tolualdehyde ?	0.0000
Other C2	3.8019
Other C3	0.0000
Other C4	1.1372
Other C5	2.0035
Other C6	5.7967
Other C7	4.0329
Other C8	1.3153
Other C9	1.7893
Other C10	0.0000
Other C11	0.0000

Table 6 - ET-02 Snapper lawnmower (5 hp)

Compound	% by mass
Methane	4.7186
Ethylene	9.4642
Ethane	1.2474
Acetylene	6.6440
Propene	3.4685
Propane	3.6475
Methylacetylene	0.6442
i-Butane	0.2177
methanol	0.2138
i-butylene	1.3349
1-butene	0.5148
1,3-Butadiene	1.2605
n-Butane	0.7184
trans-2-butene	0.0000
2,2-dimethylpropane	0.0000
cis-2-butene	0.0000
ethanol	0.0706
i-Pentane	0.9304
1-pentene	0.1802
n-Pentane	0.9361
trans-2-pentene	0.0000
cis-2-pentene	0.0000
2,2-Dimethylbutane	0.0751
Cyclopentane	0.2237
2,3-Dimethylbutane	0.0000
2-Methylpentane	0.5015
3-Methylpentane	0.6814
n-Hexane	2.0254
Methylcyclopentane	0.9247
2,4-Dimethylpentane	0.1637
Benzene	7.5099
Cyclohexane	0.0000
2-Methylhexane	0.4718
2,3-Dimethylpentane	0.1997
3-Methylhexane	0.5277
2,2,4-trimethylpentane	0.2225
n-Heptane	0.3772
Methylcyclohexane	0.3670
2,4-Dimethylhexane	0.2204
2,3,4-Trimethylpentane	0.1351
Toluene	8.6677
2,3-Dimethylhexane	0.0000
2-Methylheptane	0.1802
3-Ethylhexane	0.0000
n-Octane	0.2099
Ethylbenzene	1.6234
m-Xylene	4.8396
p-Xylene	0.0000
Styrene	0.0000
o-Xylene	2.1508
n-Nonane	0.9923
i-Propylbenzene	0.0000
n-Propylbenzene	0.0000
3-Ethyltoluene	0.0000

Compound	% by mass
1,3,5-Trimethylbenzene	0.8499
2-Ethyltoluene	0.7615
t-butylbenzene	0.0000
1,2,4-Trimethylbenzene	3.2903
i-butylbenzene	0.0000
s-butylbenzene	0.0000
n-Decane	1.1394
1,2,3-Trimethylbenzene	0.0000
indane	0.6161
1,3-Diethylbenzene	0.0000
1,4-Diethylbenzene	0.4103
n-butylbenzene	0.2292
1,2-Diethylbenzene	0.0000
1,4-dimethyl-2-ethylbenzene	0.3414
1,3-dimethyl-4-ethylbenzene	0.2887
1,2-dimethyl-4-ethylbenzene	0.0000
1,3-dimethyl-2-ethylbenzene	0.0000
n-undecane	0.0000
1,2,3,5-tetramethylbenzene	0.0000
1,2,4,5-tetramethylbenzene	0.0000
OTHER COMPOUNDS	
2-propenylbenzene	0.0000
1,2-dichlorobenzene	0.0000
2-methylstyrene	0.0000
1-ethynyl-4-methylbenzene	0.0000
naphthalene	0.0000
OXYGENATES	
formaldehyde	0.5560
acetaldehyde	0.1723
acetone	0.3140
propanal	0.0213
MEK	0.0510
butanal	0.0000
2&3-pentanone	0.0000
cyclohexanone	0.0000
pentanal	0.0000
4-methyl-2-pentanone	0.0000
2-methyl-3-pentanone	0.0000
hexanal	0.0960
benzaldehyde	0.0550
C4 ketone	0.0000
C6 ketone	0.0000
tolualdehyde ?	0.0000
Other C2	2.7975
Other C3	5.1236
Other C4	1.7719
Other C5	2.5017
Other C6	0.9364
Other C7	0.5499
Other C8	0.8661
Other C9	4.4337
Other C10	1.8710
Other C11	0.4529

Table 7 - ET-03 Sears chainsaw (2 stroke, 2 hp)

Compound	% by mass
Methane	1.9102
Ethylene	1.8361
Ethane	0.2799
Acetylene	4.8002
Propene	0.8464
Propane	0.4790
Methylacetylene	0.2769
i-Butane	0.3600
methanol	0.0000
i-butylene	0.4264
1-butene	0.2842
1,3-Butadiene	0.3231
n-Butane	1.6835
trans-2-butene	0.2479
2,2-dimethylpropane	0.0000
cis-2-butene	0.2341
ethanol	0.0000
i-Pentane	5.8151
1-pentene	0.4107
n-Pentane	2.0972
trans-2-pentene	0.1375
cis-2-pentene	0.4504
2,2-Dimethylbutane	0.6627
Cyclopentane	0.8427
2,3-Dimethylbutane	0.1418
2-Methylpentane	2.8304
3-Methylpentane	1.8057
n-Hexane	1.5411
Methylcyclopentane	2.2243
2,4-Dimethylpentane	0.6294
Benzene	3.5433
Cyclohexane	0.0778
2-Methylhexane	1.5310
2,3-Dimethylpentane	0.7643
3-Methylhexane	1.5171
2,2,4-trimethylpentane	0.4997
n-Heptane	0.0500
Methylcyclohexane	0.2987
2,4-Dimethylhexane	0.5378
2,3,4-Trimethylpentane	0.9689
Toluene	8.6891
2,3-Dimethylhexane	0.3368
2-Methylheptane	0.0000
3-Ethylhexane	0.7583
n-Octane	0.6083
Ethylbenzene	1.9852
m-Xylene	5.4906
p-Xylene	1.7884
Styrene	0.0000
o-Xylene	2.6508
n-Nonane	0.5833
i-Propylbenzene	0.1221
n-Propylbenzene	0.5649
3-Ethyltoluene	2.0581

Compound	% by mass
1,3,5-Trimethylbenzene	0.9404
2-Ethyltoluene	0.8317
t-butylbenzene	0.0000
1,2,4-Trimethylbenzene	2.4570
i-butylbenzene	0.0000
s-butylbenzene	0.0000
n-Decane	0.4821
1,2,3-Trimethylbenzene	0.0905
indane	0.1661
1,3-Diethylbenzene	0.0000
1,4-Diethylbenzene	0.0000
n-butylbenzene	0.1160
1,2-Diethylbenzene	0.0000
1,4-dimethyl-2-ethylbenzene	0.1037
1,3-dimethyl-4-ethylbenzene	0.0701
1,2-dimethyl-4-ethylbenzene	0.0915
1,3-dimethyl-2-ethylbenzene	0.0771
n-undecane	0.0757
1,2,3,5-tetramethylbenzene	0.0000
1,2,4,5-tetramethylbenzene	0.0000
OTHER COMPOUNDS	
2-propenylbenzene	0.0000
1,2-dichlorobenzene	0.0000
2-methylstyrene	0.0000
1-ethynyl-4-methylbenzene	0.0000
naphthalene	0.0000
OXYGENATES	
formaldehyde	0.1564
acetaldehyde	0.0770
acetone	0.2235
propanal	0.0170
MEK	0.0365
butanal	0.0000
2&3-pentanone	0.0000
cyclohexanone	0.0000
pentanal	0.0000
4-methyl-2-pentanone	0.0000
2-methyl-3-pentanone	0.0000
hexanal	0.0000
benzaldehyde	0.0000
C4 ketone	0.0000
C6 ketone	0.0000
tolualdehyde ?	0.0000
Other C2	0.8142
Other C3	0.0000
Other C4	0.9896
Other C5	3.5862
Other C6	6.0058
Other C7	6.3410
Other C8	3.4403
Other C9	2.0460
Other C10	1.7633
Other C11	0.0000

Table 8 - ET-04 Snapper trimmer (2 stroke, 2 hp)

Compound	% by mass
Methane	3.7875
Ethylene	1.2119
Ethane	0.2587
Acetylene	1.3383
Propene	2.1288
Propane	0.1828
Methylacetylene	0.1565
i-Butane	0.2886
methanol	0.0000
i-butylene	0.6252
1-butene	0.4957
1,3-Butadiene	0.4073
n-Butane	1.1256
trans-2-butene	0.2531
2,2-dimethylpropane	0.0000
cis-2-butene	0.2859
ethanol	0.0698
i-Pentane	5.5386
1-pentene	0.3667
n-Pentane	1.9171
trans-2-pentene	0.6899
cis-2-pentene	0.9339
2,2-Dimethylbutane	0.1508
Cyclopentane	0.8071
2,3-Dimethylbutane	0.1030
2-Methylpentane	3.2084
3-Methylpentane	2.0314
n-Hexane	1.5095
Methylcyclopentane	2.4509
2,4-Dimethylpentane	0.5815
Benzene	3.8729
Cyclohexane	0.0873
2-Methylhexane	1.7533
2,3-Dimethylpentane	0.6815
3-Methylhexane	1.7478
2,2,4-trimethylpentane	1.9523
n-Heptane	1.0934
Methylcyclohexane	0.3363
2,4-Dimethylhexane	0.6127
2,3,4-Trimethylpentane	0.9277
Toluene	10.5065
2,3-Dimethylhexane	0.3438
2-Methylheptane	0.8318
3-Ethylhexane	0.8321
n-Octane	0.6079
Ethylbenzene	1.7740
m-Xylene	6.3193
p-Xylene	1.9941
Styrene	0.3001
o-Xylene	2.8678
n-Nonane	0.4612
i-Propylbenzene	0.1377
n-Propylbenzene	0.5441
3-Ethyltoluene	1.8878

Compound	% by mass
1,3,5-Trimethylbenzene	0.8536
2-Ethyltoluene	0.6916
t-butylbenzene	0.0000
1,2,4-Trimethylbenzene	1.6593
i-butylbenzene	0.0491
s-butylbenzene	0.0652
n-Decane	0.2745
1,2,3-Trimethylbenzene	0.2315
indane	0.0000
1,3-Diethylbenzene	0.0000
1,4-Diethylbenzene	0.0000
n-butylbenzene	0.0460
1,2-Diethylbenzene	0.0000
1,4-dimethyl-2-ethylbenzene	0.0559
1,3-dimethyl-4-ethylbenzene	0.0000
1,2-dimethyl-4-ethylbenzene	0.0557
1,3-dimethyl-2-ethylbenzene	0.0000
n-undecane	0.0000
1,2,3,5-tetramethylbenzene	0.0000
1,2,4,5-tetramethylbenzene	0.0000
OTHER COMPOUNDS	
2-propenylbenzene	0.0000
1,2-dichlorobenzene	0.0000
2-methylstyrene	0.0000
1-ethynyl-4-methylbenzene	0.0000
naphthalene	0.0000
OXYGENATES	
formaldehyde	0.0101
acetaldehyde	0.0279
acetone	0.0184
propanal	0.0069
MEK	0.0129
butanal	0.0000
2&3-pentanone	0.0000
cyclohexanone	0.0006
pentanal	0.0003
4-methyl-2-pentanone	0.0255
2-methyl-3-pentanone	0.0009
hexanal	0.0123
benzaldehyde	0.0111
C4 ketone	0.0111
C6 ketone	0.0000
tolualdehyde ?	0.0000
Other C2	0.4122
Other C3	0.0000
Other C4	1.0184
Other C5	2.6397
Other C6	5.4865
Other C7	5.0325
Other C8	3.3566
Other C9	1.9003
Other C10	0.6552
Other C11	0.0000

Table 9 - ET-05 Sears lawnmower (3 hp)

Compound	% by mass
Methane	2.2788
Ethylene	8.2577
Ethane	0.4964
Acetylene	17.7112
Propene	3.3263
Propane	0.5560
Methylacetylene	1.2840
i-Butane	0.2207
methanol	0.1379
i-butylene	1.6062
1-butene	0.9238
1,3-Butadiene	1.5316
n-Butane	0.7251
trans-2-butene	0.2102
2,2-dimethylpropane	0.0000
cis-2-butene	0.1576
ethanol	0.0525
i-Pentane	1.4929
1-pentene	0.0000
n-Pentane	1.1221
trans-2-pentene	0.2197
cis-2-pentene	0.2496
2,2-Dimethylbutane	0.1248
Cyclopentane	0.0000
2,3-Dimethylbutane	0.1741
2-Methylpentane	0.7980
3-Methylpentane	0.5195
n-Hexane	0.8581
Methylcyclopentane	0.5773
2,4-Dimethylpentane	0.1051
Benzene	5.2688
Cyclohexane	0.0000
2-Methylhexane	0.1576
2,3-Dimethylpentane	0.0000
3-Methylhexane	0.4407
2,2,4-trimethylpentane	0.3714
n-Heptane	0.4880
Methylcyclohexane	0.2844
2,4-Dimethylhexane	0.1379
2,3,4-Trimethylpentane	0.1901
Toluene	5.8380
2,3-Dimethylhexane	0.0000
2-Methylheptane	0.3018
3-Ethylhexane	0.0000
n-Octane	0.3668
Ethylbenzene	1.5775
m-Xylene	4.3566
p-Xylene	0.0000
Styrene	0.5080
o-Xylene	1.9600
n-Nonane	1.0643
i-Propylbenzene	0.0000
n-Propylbenzene	0.4554
3-Ethyltoluene	1.7925

Compound	% by mass
1,3,5-Trimethylbenzene	0.8109
2-Ethyltoluene	0.6858
t-butylbenzene	0.0000
1,2,4-Trimethylbenzene	2.8694
i-butylbenzene	0.0000
s-butylbenzene	0.0000
n-Decane	0.0000
1,2,3-Trimethylbenzene	0.5780
indane	0.0000
1,3-Diethylbenzene	0.2122
1,4-Diethylbenzene	0.1966
n-butylbenzene	0.0000
1,2-Diethylbenzene	0.0000
1,4-dimethyl-2-ethylbenzene	0.3271
1,3-dimethyl-4-ethylbenzene	0.0000
1,2-dimethyl-4-ethylbenzene	0.0000
1,3-dimethyl-2-ethylbenzene	0.0000
n-undecane	0.0000
1,2,3,5-tetramethylbenzene	0.0000
1,2,4,5-tetramethylbenzene	0.0000
OTHER COMPOUNDS	
2-propenylbenzene	0.0000
1,2-dichlorobenzene	0.0000
2-methylstyrene	0.0000
1-ethynyl-4-methylbenzene	0.0000
naphthalene	0.0000
OXYGENATES	
formaldehyde	3.1622
acetaldehyde	0.1441
acetone	0.1129
propanal	0.0289
MEK	0.0000
butanal	0.0000
2&3-pentanone	0.0000
cyclohexanone	0.0000
pentanal	0.0000
4-methyl-2-pentanone	0.0000
2-methyl-3-pentanone	0.1009
hexanal	0.0867
benzaldehyde	0.0153
C4 ketone	0.0000
C6 ketone	0.0000
tolualdehyde ?	0.0000
Other C2	6.2977
Other C3	1.0985
Other C4	1.4591
Other C5	2.3224
Other C6	1.3087
Other C7	0.6535
Other C8	0.9609
Other C9	2.2791
Other C10	3.0117
Other C11	0.0000

Table 10 - ET-06 Mc Lane edger (2 hp)

Compound	% by mass
Methane	4.4945
Ethylene	10.9160
Ethane	1.3248
Acetylene	5.9945
Propene	6.2566
Propane	0.4583
Methylacetylene	1.9371
i-Butane	0.1051
methanol	0.1289
i-butylene	1.2888
1-butene	1.5741
1,3-Butadiene	2.8171
n-Butane	0.2996
trans-2-butene	0.2364
2,2-dimethylpropane	0.0000
cis-2-butene	0.0000
ethanol	0.0360
i-Pentane	1.3060
1-pentene	0.1156
n-Pentane	0.2602
trans-2-pentene	0.6194
cis-2-pentene	0.1531
2,2-Dimethylbutane	0.1269
Cyclopentane	0.0000
2,3-Dimethylbutane	0.2196
2-Methylpentane	0.8299
3-Methylpentane	0.1657
n-Hexane	0.3132
Methylcyclopentane	0.5683
2,4-Dimethylpentane	0.1093
Benzene	3.9106
Cyclohexane	0.0415
2-Methylhexane	0.3366
2,3-Dimethylpentane	0.1262
3-Methylhexane	0.3374
2,2,4-trimethylpentane	0.1900
n-Heptane	0.0400
Methylcyclohexane	0.1307
2,4-Dimethylhexane	0.1154
2,3,4-Trimethylpentane	0.1935
Toluene	3.9900
2,3-Dimethylhexane	0.0624
2-Methylheptane	0.1574
3-Ethylhexane	0.1432
n-Octane	0.1980
Ethylbenzene	1.0179
m-Xylene	2.9010
p-Xylene	0.0000
Styrene	0.0000
o-Xylene	0.9594
n-Nonane	0.0558
i-Propylbenzene	0.0812
n-Propylbenzene	0.1758
3-Ethyltoluene	0.9787

Compound	% by mass
1,3,5-Trimethylbenzene	0.4376
2-Ethyltoluene	0.4089
t-butylbenzene	0.0000
1,2,4-Trimethylbenzene	1.4655
i-butylbenzene	0.0000
s-butylbenzene	0.0000
n-Decane	0.0571
1,2,3-Trimethylbenzene	0.2869
indane	0.6563
1,3-Diethylbenzene	0.0000
1,4-Diethylbenzene	0.1956
n-butylbenzene	0.1175
1,2-Diethylbenzene	0.3604
1,4-dimethyl-2-ethylbenzene	0.0000
1,3-dimethyl-4-ethylbenzene	0.0000
1,2-dimethyl-4-ethylbenzene	0.1833
1,3-dimethyl-2-ethylbenzene	0.0000
n-undecane	0.0000
1,2,3,5-tetramethylbenzene	0.0728
1,2,4,5-tetramethylbenzene	0.0000
OTHER COMPOUNDS	
2-propenylbenzene	0.0000
1,2-dichlorobenzene	0.0000
2-methylstyrene	0.0000
1-ethynyl-4-methylbenzene	0.0000
naphthalene	0.0000
OXYGENATES	
formaldehyde	0.5840
acetaldehyde	0.2392
acetone	0.2314
propanal	0.0356
MEK	0.0454
butanal	0.0197
2&3-pentanone	0.0000
cyclohexanone	0.0142
pentanal	0.0143
4-methyl-2-pentanone	0.0951
2-methyl-3-pentanone	0.0366
hexanal	0.2936
benzaldehyde	0.0527
C4 ketone	0.0928
C6 ketone	0.0000
tolualdehyde ?	0.0000
Other C2	19.5884
Other C3	0.4100
Other C4	1.9738
Other C5	3.4178
Other C6	3.1802
Other C7	1.5787
Other C8	1.1173
Other C9	0.9257
Other C10	0.9622
Other C11	2.0518

Table 11 - ET-08 Husqvarna chainsaw (10 hp)

Compound	% by mass
Methane	9.1070
Ethylene	2.6137
Ethane	0.2586
Acetylene	2.8315
Propene	0.6513
Propane	0.6787
Methylacetylene	0.2062
i-Butane	0.1054
methanol	0.0827
i-butylene	0.0767
1-butene	1.0669
1,3-Butadiene	0.4649
n-Butane	0.4527
trans-2-butene	0.1791
2,2-dimethylpropane	0.0000
cis-2-butene	0.1346
ethanol	0.0230
i-Pentane	3.7059
1-pentene	0.2868
n-Pentane	1.2417
trans-2-pentene	0.2246
cis-2-pentene	0.2545
2,2-Dimethylbutane	0.1650
Cyclopentane	0.2488
2,3-Dimethylbutane	0.6363
2-Methylpentane	2.3272
3-Methylpentane	1.4945
n-Hexane	0.9316
Methylcyclopentane	1.8561
2,4-Dimethylpentane	0.6006
Benzene	3.3129
Cyclohexane	0.2510
2-Methylhexane	1.3255
2,3-Dimethylpentane	0.5655
3-Methylhexane	1.2692
2,2,4-trimethylpentane	2.2062
n-Heptane	0.8188
Methylcyclohexane	0.8004
2,4-Dimethylhexane	0.5749
2,3,4-Trimethylpentane	1.0508
Toluene	8.4391
2,3-Dimethylhexane	0.3056
2-Methylheptane	0.6016
3-Ethylhexane	0.8207
n-Octane	0.3928
Ethylbenzene	2.0789
m-Xylene	0.0054
p-Xylene	1.8180
Styrene	0.0000
o-Xylene	5.3845
n-Nonane	0.3672
i-Propylbenzene	0.3648
n-Propylbenzene	0.6014
3-Ethyltoluene	2.4765

Compound	% by mass
1,3,5-Trimethylbenzene	1.1240
2-Ethyltoluene	1.0125
t-butylbenzene	0.0000
1,2,4-Trimethylbenzene	3.4335
i-butylbenzene	0.0854
s-butylbenzene	0.1037
n-Decane	0.2819
1,2,3-Trimethylbenzene	0.7524
indane	0.2080
1,3-Diethylbenzene	0.0000
1,4-Diethylbenzene	0.6818
n-butylbenzene	0.0000
1,2-Diethylbenzene	0.8143
1,4-dimethyl-2-ethylbenzene	0.0000
1,3-dimethyl-4-ethylbenzene	0.0000
1,2-dimethyl-4-ethylbenzene	0.3934
1,3-dimethyl-2-ethylbenzene	0.0000
n-undecane	0.0000
1,2,3,5-tetramethylbenzene	0.0000
1,2,4,5-tetramethylbenzene	0.0000
OTHER COMPOUNDS	
2-propenylbenzene	0.0000
1,2-dichlorobenzene	0.0000
2-methylstyrene	0.0000
1-ethynyl-4-methylbenzene	0.0000
naphthalene	0.0000
OXYGENATES	
formaldehyde	0.5983
acetaldehyde	0.2762
acetone	0.5461
propanal	0.0623
MEK	0.1428
butanal	0.0000
2&3-pentanone	0.0000
cyclohexanone	0.0000
pentanal	0.0000
4-methyl-2-pentanone	0.1436
2-methyl-3-pentanone	0.0812
hexanal	0.0000
benzaldehyde	0.0526
C4 ketone	0.0855
C6 ketone	0.0000
tolualdehyde ?	0.0000
Other C2	1.2841
Other C3	0.0486
Other C4	1.2908
Other C5	2.2720
Other C6	4.9000
Other C7	2.8654
Other C8	2.6308
Other C9	2.1370
Other C10	2.8891
Other C11	0.0646

Table 12 - ET-09 Toro blower (2 stroke, 1.5 hp)

Compound	% by mass
Methane	0.7285
Ethylene	0.6301
Ethane	0.0775
Acetylene	1.1660
Propene	0.2525
Propane	0.8035
Methylacetylene	0.0255
i-Butane	0.3185
methanol	0.3065
i-butylene	0.2787
1-butene	0.5064
1,3-Butadiene	0.1357
n-Butane	0.6031
trans-2-butene	0.0000
2,2-dimethylpropane	0.0000
cis-2-butene	0.0000
ethanol	0.0357
i-Pentane	3.3483
1-pentene	0.1658
n-Pentane	1.2154
trans-2-pentene	0.0459
cis-2-pentene	0.1262
2,2-Dimethylbutane	0.9930
Cyclopentane	0.2537
2,3-Dimethylbutane	0.6661
2-Methylpentane	2.5062
3-Methylpentane	1.6295
n-Hexane	1.1180
Methylcyclopentane	2.1803
2,4-Dimethylpentane	0.6171
Benzene	2.4998
Cyclohexane	0.0281
2-Methylhexane	1.6157
2,3-Dimethylpentane	0.7054
3-Methylhexane	1.6310
2,2,4-trimethylpentane	0.5636
n-Heptane	0.9764
Methylcyclohexane	0.2989
2,4-Dimethylhexane	0.7347
2,3,4-Trimethylpentane	1.3118
Toluene	9.7274
2,3-Dimethylhexane	0.2303
2-Methylheptane	0.7877
3-Ethylhexane	0.7916
n-Octane	0.6276
Ethylbenzene	2.6420
m-Xylene	7.6398
p-Xylene	2.5181
Styrene	0.0000
o-Xylene	3.6511
n-Nonane	0.4725
i-Propylbenzene	0.1737
n-Propylbenzene	1.0113
3-Ethyltoluene	3.9106

Compound	% by mass
1,3,5-Trimethylbenzene	1.7942
2-Ethyltoluene	1.6007
t-butylbenzene	0.0000
1,2,4-Trimethylbenzene	5.4364
i-butylbenzene	0.0635
s-butylbenzene	0.1723
n-Decane	0.6176
1,2,3-Trimethylbenzene	0.1573
indane	0.1518
1,3-Diethylbenzene	0.0000
1,4-Diethylbenzene	0.7656
n-butylbenzene	0.7840
1,2-Diethylbenzene	0.0000
1,4-dimethyl-2-ethylbenzene	0.3487
1,3-dimethyl-4-ethylbenzene	0.2032
1,2-dimethyl-4-ethylbenzene	0.2957
1,3-dimethyl-2-ethylbenzene	0.2120
n-undecane	0.0000
1,2,3,5-tetramethylbenzene	0.0000
1,2,4,5-tetramethylbenzene	0.0000
OTHER COMPOUNDS	
2-propenylbenzene	0.0000
1,2-dichlorobenzene	0.0000
2-methylstyrene	0.0000
1-ethynyl-4-methylbenzene	0.0000
naphthalene	0.0000
OXYGENATES	
formaldehyde	0.1093
acetaldehyde	0.0563
acetone	0.0429
propanal	0.0228
MEK	0.0171
butanal	0.0147
2&3-pentanone	0.0016
cyclohexanone	0.0108
pentanal	0.0008
4-methyl-2-pentanone	0.0053
2-methyl-3-pentanone	0.0070
hexanal	0.0358
benzaldehyde	0.0186
C4 ketone	0.0145
C6 ketone	0.0000
tolualdehyde ?	0.0000
Other C2	1.5127
Other C3	0.0000
Other C4	0.2461
Other C5	1.3332
Other C6	6.3222
Other C7	3.6928
Other C8	2.6065
Other C9	3.0305
Other C10	3.0127
Other C11	0.0000

Table 13 - ET-10 Swirl Magic lawnmower (3 hp)

Compound	% by mass	Compound	% by mass
Methane	12.3172	1,3,5-Trimethylbenzene	0.7360
Ethylene	7.4521	2-Ethyltoluene	0.6275
Ethane	0.9531	t-butylbenzene	0.0000
Acetylene	7.0708	1,2,4-Trimethylbenzene	2.0418
Propene	3.4981	i-butylbenzene	0.0339
		s-butylbenzene	0.0437
Propane	0.2706	n-Decane	0.1156
Methylacetylene	0.6787	1,2,3-Trimethylbenzene	0.2962
i-Butane	0.2626	indane	0.1484
methanol	0.1086	1,3-Diethylbenzene	0.0000
i-butylene	1.4839	1,4-Diethylbenzene	0.1379
1-butene	0.8090	n-butylbenzene	0.0533
1,3-Butadiene	1.3788	1,2-Diethylbenzene	0.0000
n-Butane	0.9386	1,4-dimethyl-2-ethylbenzene	0.0000
trans-2-butene	0.3857	1,3-dimethyl-4-ethylbenzene	0.0628
2,2-dimethylpropane	0.0000	1,2-dimethyl-4-ethylbenzene	0.0000
cis-2-butene	0.3070	1,3-dimethyl-2-ethylbenzene	0.0606
ethanol	0.0000	n-undecane	0.0000
i-Pentane	3.6077	1,2,3,5-tetramethylbenzene	0.0000
1-pentene	0.2905	1,2,4,5-tetramethylbenzene	0.0000
n-Pentane	1.2466	OTHER COMPOUNDS	
trans-2-pentene	0.5940	2-propenylbenzene	0.0000
cis-2-pentene	0.2472	1,2-dichlorobenzene	0.0000
2,2-Dimethylbutane	0.1606	2-methylstyrene	0.6583
Cyclopentane	0.3988	1-ethynyl-4-methylbenzene	0.0081
2,3-Dimethylbutane	0.0460	naphthalene	0.7971
2-Methylpentane	1.6579	OXYGENATES	
3-Methylpentane	1.0483	formaldehyde	0.8210
n-Hexane	0.8096	acetaldehyde	0.1750
Methylcyclopentane	1.2432	acetone	0.1685
2,4-Dimethylpentane	0.2691	propanal	0.0385
Benzene	4.8613	MEK	0.0461
Cyclohexane	0.0345	butanal	0.0154
2-Methylhexane	0.7433	2&3-pentanone	0.0000
2,3-Dimethylpentane	0.2946	cyclohexanone	0.0139
3-Methylhexane	0.7294	pentanal	0.0000
2,2,4-trimethylpentane	0.6709	4-methyl-2-pentanone	0.0721
n-Heptane	0.5411	2-methyl-3-pentanone	0.0207
Methylcyclohexane	0.4471	hexanal	0.0231
2,4-Dimethylhexane	0.2116	benzaldehyde	0.0000
2,3,4-Trimethylpentane	0.2854	C4 ketone	0.0293
Toluene	7.7897	C6 ketone	0.1289
2,3-Dimethylhexane	0.1180	tolualdehyde ?	0.0000
2-Methylheptane	0.3292	Other C2	1.3656
3-Ethylhexane	0.3205	Other C3	0.1069
n-Octane	0.2720	Other C4	1.2393
Ethylbenzene	1.7420	Other C5	2.8349
m-Xylene	4.4973	Other C6	2.5428
p-Xylene	1.4996	Other C7	1.6126
Styrene	0.0000	Other C8	1.7489
o-Xylene	2.0792	Other C9	1.3687
n-Nonane	0.1565	Other C10	0.5496
i-Propylbenzene	0.0762	Other C11	0.0000
n-Propylbenzene	0.3392		
3-Ethyltoluene	1.6844		

Table 14 - ET-11 Swirl Magic lawnmower (3 hp)

Compound	% by mass
Methane	8.4401
Ethylene	7.3841
Ethane	0.9230
Acetylene	9.4804
Propene	3.7195
Propane	0.1459
Methylacetylene	0.4185
i-Butane	0.2562
methanol	0.0809
i-butylene	1.3373
1-butene	0.7917
1,3-Butadiene	1.2842
n-Butane	0.8983
trans-2-butene	0.3641
2,2-dimethylpropane	0.0000
cis-2-butene	0.2881
ethanol	0.0534
i-Pentane	3.4600
1-pentene	0.2781
n-Pentane	1.1572
trans-2-pentene	0.5304
cis-2-pentene	0.2357
2,2-Dimethylbutane	0.6045
Cyclopentane	0.1985
2,3-Dimethylbutane	0.3842
2-Methylpentane	1.5791
3-Methylpentane	0.6810
n-Hexane	0.7480
Methylcyclopentane	1.1765
2,4-Dimethylpentane	0.2616
Benzene	4.1764
Cyclohexane	0.0337
2-Methylhexane	0.7122
2,3-Dimethylpentane	0.2901
3-Methylhexane	0.6973
2,2,4-trimethylpentane	0.6621
n-Heptane	0.0412
Methylcyclohexane	0.4283
2,4-Dimethylhexane	0.2046
2,3,4-Trimethylpentane	0.2839
Toluene	6.7268
2,3-Dimethylhexane	0.1063
2-Methylheptane	0.3130
3-Ethylhexane	0.3066
n-Octane	0.2526
Ethylbenzene	1.5863
m-Xylene	4.0986
p-Xylene	1.3619
Styrene	0.5943
o-Xylene	1.9286
n-Nonane	0.1366
i-Propylbenzene	0.0750
n-Propylbenzene	0.3598
3-Ethyltoluene	1.8133

Compound	% by mass
1,3,5-Trimethylbenzene	0.8014
2-Ethyltoluene	0.8961
t-butylbenzene	0.0000
1,2,4-Trimethylbenzene	2.9129
i-butylbenzene	0.0444
s-butylbenzene	0.0553
n-Decane	0.1350
1,2,3-Trimethylbenzene	0.5743
indane	0.5651
1,3-Diethylbenzene	0.0000
1,4-Diethylbenzene	0.4122
n-butylbenzene	0.6659
1,2-Diethylbenzene	0.0000
1,4-dimethyl-2-ethylbenzene	0.3438
1,3-dimethyl-4-ethylbenzene	0.3455
1,2-dimethyl-4-ethylbenzene	0.4309
1,3-dimethyl-2-ethylbenzene	0.1788
n-undecane	0.0943
1,2,3,5-tetramethylbenzene	0.0000
1,2,4,5-tetramethylbenzene	0.1817
OTHER COMPOUNDS	
2-propenylbenzene	0.0000
1,2-dichlorobenzene	0.0000
2-methylstyrene	0.0000
1-ethynyl-4-methylbenzene	0.0000
naphthalene	0.0000
OXYGENATES	
formaldehyde	0.6614
acetaldehyde	0.1408
acetone	0.1436
propanal	0.0283
MEK	0.0368
butanal	0.0102
2&3-pentanone	0.0000
cyclohexanone	0.0114
pentanal	0.0000
4-methyl-2-pentanone	0.0666
2-methyl-3-pentanone	0.0154
hexanal	0.0201
benzaldehyde	0.0000
C4 ketone	0.0269
C6 ketone	0.1137
tolualdehyde ?	0.0000
Other C2	2.9143
Other C3	0.0906
Other C4	1.2379
Other C5	2.3149
Other C6	2.6658
Other C7	2.1598
Other C8	1.1480
Other C9	1.6944
Other C10	1.3004
Other C11	0.2114

Table 15 - ET-12 Mont. Ward rototiller (5 hp)

Compound	% by mass
Methane	5.5878
Ethylene	6.9063
Ethane	0.7534
Acetylene	6.9691
Propene	4.5852
Propane	0.4843
Methylacetylene	1.3308
i-Butane	0.7248
methanol	0.4401
i-butylene	1.0526
1-butene	0.3757
1,3-Butadiene	1.3815
n-Butane	0.6964
trans-2-butene	0.2220
2,2-dimethylpropane	0.0000
cis-2-butene	0.1804
ethanol	0.0000
i-Pentane	1.1976
1-pentene	0.1442
n-Pentane	0.7758
trans-2-pentene	0.1966
cis-2-pentene	0.1082
2,2-Dimethylbutane	0.0000
Cyclopentane	0.0000
2,3-Dimethylbutane	0.2370
2-Methylpentane	1.0321
3-Methylpentane	0.7949
n-Hexane	1.0429
Methylcyclopentane	0.7623
2,4-Dimethylpentane	0.1696
Benzene	4.4417
Cyclohexane	0.0000
2-Methylhexane	0.4289
2,3-Dimethylpentane	0.2170
3-Methylhexane	0.5417
2,2,4-trimethylpentane	0.4279
n-Heptane	0.5874
Methylcyclohexane	0.5278
2,4-Dimethylhexane	0.1494
2,3,4-Trimethylpentane	0.0000
Toluene	4.8772
2,3-Dimethylhexane	0.0000
2-Methylheptane	0.0000
3-Ethylhexane	0.2673
n-Octane	0.2822
Ethylbenzene	0.9473
m-Xylene	0.0000
p-Xylene	4.0469
Styrene	0.0000
o-Xylene	1.4039
n-Nonane	0.3275
i-Propylbenzene	0.0541
n-Propylbenzene	0.3281
3-Ethyltoluene	1.5835

Compound	% by mass
1,3,5-Trimethylbenzene	0.7085
2-Ethyltoluene	0.0000
t-butylbenzene	0.0000
1,2,4-Trimethylbenzene	2.9890
i-butylbenzene	0.0575
s-butylbenzene	0.0673
n-Decane	0.4889
1,2,3-Trimethylbenzene	0.2229
indane	0.6524
1,3-Diethylbenzene	0.0000
1,4-Diethylbenzene	0.0000
n-butylbenzene	0.2727
1,2-Diethylbenzene	0.0000
1,4-dimethyl-2-ethylbenzene	0.4389
1,3-dimethyl-4-ethylbenzene	0.3327
1,2-dimethyl-4-ethylbenzene	0.5490
1,3-dimethyl-2-ethylbenzene	0.2449
n-undecane	0.8859
1,2,3,5-tetramethylbenzene	0.2559
1,2,4,5-tetramethylbenzene	0.3613
OTHER COMPOUNDS	
2-propenylbenzene	0.0000
1,2-dichlorobenzene	0.0000
2-methylstyrene	0.0000
1-ethynyl-4-methylbenzene	0.0000
naphthalene	0.0000
OXYGENATES	
formaldehyde	2.4286
acetaldehyde	0.4343
acetone	0.7140
propanal	0.0689
MEK	0.1633
butanal	0.0000
2&3-pentanone	0.0000
cyclohexanone	0.1347
pentanal	0.0000
4-methyl-2-pentanone	0.2177
2-methyl-3-pentanone	0.1831
hexanal	0.0941
benzaldehyde	0.1216
C4 ketone	0.0000
C6 ketone	0.2048
tolualdehyde ?	0.0000
Other C2	3.0970
Other C3	1.3861
Other C4	1.8784
Other C5	1.3339
Other C6	0.9879
Other C7	0.8229
Other C8	2.3345
Other C9	6.1398
Other C10	7.6501
Other C11	1.4851

Table 16 - ET-13 Lawn Chief riding mower (12 hp)

Compound	% by mass
Methane	12.5642
Ethylene	8.7389
Ethane	0.6925
Acetylene	10.8164
Propene	4.2313
Propane	0.1633
Methylacetylene	1.0183
i-Butane	0.1346
methanol	
i-butylene	1.6376
1-butene	0.5690
1,3-Butadiene	0.2138
n-Butane	0.6633
trans-2-butene	0.2784
2,2-dimethylpropane	0.0000
cis-2-butene	0.2220
ethanol	
i-Pentane	2.0353
1-pentene	0.1914
n-Pentane	1.1256
trans-2-pentene	0.0000
cis-2-pentene	0.0000
2,2-Dimethylbutane	0.0000
Cyclopentane	0.0000
2,3-Dimethylbutane	0.0000
2-Methylpentane	1.0711
3-Methylpentane	0.6755
n-Hexane	0.8856
Methylcyclopentane	0.7537
2,4-Dimethylpentane	0.4340
Benzene	7.2653
Cyclohexane	0.0000
2-Methylhexane	0.5151
2,3-Dimethylpentane	0.6459
3-Methylhexane	0.5654
2,2,4-trimethylpentane	0.8373
n-Heptane	0.4568
Methylcyclohexane	0.2591
2,4-Dimethylhexane	0.2132
2,3,4-Trimethylpentane	0.3486
Toluene	10.1138
2,3-Dimethylhexane	0.1417
2-Methylheptane	0.2574
3-Ethylhexane	0.2461
n-Octane	0.2206
Ethylbenzene	1.7216
m-Xylene	0.0000
p-Xylene	5.5018
Styrene	0.0000
o-Xylene	2.4997
n-Nonane	0.1623
i-Propylbenzene	0.0000
n-Propylbenzene	0.3490
3-Ethyltoluene	1.8374

Compound	% by mass
1,3,5-Trimethylbenzene	0.8128
2-Ethyltoluene	0.6814
t-butylbenzene	0.0000
1,2,4-Trimethylbenzene	2.9008
i-butylbenzene	0.0000
s-butylbenzene	0.0000
n-Decane	0.0000
1,2,3-Trimethylbenzene	0.5050
indane	0.0000
1,3-Diethylbenzene	0.0000
1,4-Diethylbenzene	0.0000
n-butylbenzene	0.3729
1,2-Diethylbenzene	0.0000
1,4-dimethyl-2-ethylbenzene	0.1598
1,3-dimethyl-4-ethylbenzene	0.1399
1,2-dimethyl-4-ethylbenzene	0.1629
1,3-dimethyl-2-ethylbenzene	0.0000
n-undecane	0.0000
1,2,3,5-tetramethylbenzene	0.0000
1,2,4,5-tetramethylbenzene	0.0000
OTHER COMPOUNDS	
2-propenylbenzene	0.0000
1,2-dichlorobenzene	0.0000
2-methylstyrene	0.9529
1-ethynyl-4-methylbenzene	1.0524
naphthalene	0.0000
OXYGENATES	
formaldehyde	0.7189
acetaldehyde	0.2210
acetone	0.3306
propanal	0.0285
MEK	0.0828
butanal	0.0000
2&3-pentanone	0.0000
cyclohexanone	0.0000
pentanal	0.0000
4-methyl-2-pentanone	0.2641
2-methyl-3-pentanone	0.0814
hexanal	0.0426
benzaldehyde	0.0788
C4 ketone	0.0321
C6 ketone	0.1638
tolualdehyde ?	0.0000
Other C2	0.2981
Other C3	0.7260
Other C4	0.2076
Other C5	1.5304
Other C6	0.7654
Other C7	0.2776
Other C8	0.8728
Other C9	1.4583
Other C10	0.5220
Other C11	0.0000

Table 17 - ET-15 Sears rototiller (gas, 8 hp)

Compound	% by mass
Methane	2.2885
Ethylene	9.8711
Ethane	1.5867
Acetylene	7.4453
Propene	2.3996
Propane	0.3018
Methylacetylene	0.5994
i-Butane	0.1200
methanol	0.2555
i-butylene	0.6069
1-butene	0.4216
1,3-Butadiene	0.8714
n-Butane	0.6088
trans-2-butene	0.1409
2,2-dimethylpropane	0.0000
cis-2-butene	0.1051
ethanol	0.0000
i-Pentane	1.6989
1-pentene	0.2440
ethanol	
n-Pentane	0.2656
trans-2-pentene	0.2530
cis-2-pentene	0.1062
2,2-Dimethylbutane	0.0000
Cyclopentane	0.0000
2,3-Dimethylbutane	0.1874
2-Methylpentane	0.7759
3-Methylpentane	0.5076
n-Hexane	1.5278
Methylcyclopentane	0.6230
2,4-Dimethylpentane	0.1280
Benzene	5.2782
Cyclohexane	0.0000
2-Methylhexane	0.3359
2,3-Dimethylpentane	0.1518
3-Methylhexane	0.3757
2,2,4-trimethylpentane	0.1546
n-Heptane	0.3185
Methylcyclohexane	0.2436
2,4-Dimethylhexane	0.1079
2,3,4-Trimethylpentane	0.1533
Toluene	6.1387
2,3-Dimethylhexane	0.0000
2-Methylheptane	0.0000
3-Ethylhexane	0.0000
n-Octane	0.1661
Ethylbenzene	1.2243
m-Xylene	0.0000
p-Xylene	5.8142
Styrene	0.0000
o-Xylene	1.9150
n-Nonane	0.2834
i-Propylbenzene	0.0000
n-Propylbenzene	0.3627
3-Ethyltoluene	2.1057

Compound	% by mass
1,3,5-Trimethylbenzene	0.8978
2-Ethyltoluene	0.8771
t-butylbenzene	0.0000
1,2,4-Trimethylbenzene	4.5399
i-butylbenzene	0.0000
s-butylbenzene	0.0000
n-Decane	0.0000
1,2,3-Trimethylbenzene	1.1097
indane	0.0000
1,3-Diethylbenzene	0.0000
1,4-Diethylbenzene	0.0000
n-butylbenzene	1.8419
1,2-Diethylbenzene	0.0000
1,4-dimethyl-2-ethylbenzene	0.8678
1,3-dimethyl-4-ethylbenzene	0.6974
1,2-dimethyl-4-ethylbenzene	1.1712
1,3-dimethyl-2-ethylbenzene	0.4537
n-undecane	1.0216
1,2,3,5-tetramethylbenzene	0.5683
1,2,4,5-tetramethylbenzene	0.9704
OTHER COMPOUNDS	
2-propenylbenzene	0.0000
1,2-dichlorobenzene	0.0000
2-methylstyrene	0.0000
1-ethynyl-4-methylbenzene	0.0000
naphthalene	0.0000
OXYGENATES	
formaldehyde	1.5810
acetaldehyde	1.0038
acetone	0.8273
propanal	1.1289
MEK	0.0000
butanal	0.0000
2&3-pentanone	0.0000
cyclohexanone	0.0000
pentanal	0.0000
4-methyl-2-pentanone	0.0000
2-methyl-3-pentanone	0.0000
hexanal	0.5588
benzaldehyde	0.4944
C4 ketone	0.0000
C6 ketone	0.0000
tolualdehyde ?	0.0000
Other C2	1.6191
Other C3	1.9307
Other C4	0.7472
Other C5	1.9839
Other C6	0.8010
Other C7	0.4214
Other C8	1.8993
Other C9	3.6157
Other C10	4.6434
Other C11	2.6582

Table 18 - ET-17 Ford diesel tractor (130 hp)

Compound	% by mass	Compound	% by mass
Methane	0.8140	1,3,5-Trimethylbenzene	0.1442
Ethylene	11.7762	2-Ethyltoluene	0.0000
Ethane	0.1899	t-butylbenzene	0.0000
Acetylene	2.3064	1,2,4-Trimethylbenzene	0.0000
Propene	3.6814	i-butylbenzene	0.7139
		s-butylbenzene	0.0000
Propane	0.0000	n-Decane	1.0099
Methylacetylene	0.2861	1,2,3-Trimethylbenzene	0.0000
i-Butane	2.5084	indane	0.8259
methanol	0.0000	1,3-Diethylbenzene	0.0000
i-butylene	0.7552	1,4-Diethylbenzene	0.0000
1-butene	1.1784	n-butylbenzene	0.3727
1,3-Butadiene	0.0000	1,2-Diethylbenzene	0.0000
n-Butane	0.0000	1,4-dimethyl-2-ethylbenzene	0.5263
trans-2-butene	0.3517	1,3-dimethyl-4-ethylbenzene	0.2640
2,2-dimethylpropane	0.0000	1,2-dimethyl-4-ethylbenzene	0.4082
cis-2-butene	0.1310	1,3-dimethyl-2-ethylbenzene	0.3939
ethanol	0.0000	n-undecane	1.7610
i-Pentane	1.2323	1,2,3,5-tetramethylbenzene	0.2863
1-pentene	0.5115	1,2,4,5-tetramethylbenzene	0.3500
n-Pentane	0.2314	OTHER COMPOUNDS	
trans-2-pentene	0.0000	2-propenylbenzene	0.0000
cis-2-pentene	0.0000	1,2-dichlorobenzene	0.0000
2,2-Dimethylbutane	0.0000	2-methylstyrene	0.0000
Cyclopentane	0.0000	1-ethynyl-4-methylbenzene	0.0000
2,3-Dimethylbutane	0.0000	naphthalene	0.0000
2-Methylpentane	0.9766	OXYGENATES	
3-Methylpentane	0.0000	formaldehyde	13.8609
n-Hexane	0.0000	acetaldehyde	5.5769
Methylcyclopentane	0.4614	acetone	3.4737
2,4-Dimethylpentane	0.0000	propanal	1.0996
Benzene	1.0546	MEK	0.6891
Cyclohexane	0.1047	butanal	0.9395
2-Methylhexane	0.2441	2&3-pentanone	0.0000
2,3-Dimethylpentane	0.0000	cyclohexanone	0.4923
3-Methylhexane	0.6024	pentanal	0.4698
2,2,4-trimethylpentane	0.3088	4-methyl-2-pentanone	0.0000
n-Heptane	0.0000	2-methyl-3-pentanone	0.0000
Methylcyclohexane	0.0000	hexanal	2.4875
2,4-Dimethylhexane	0.0000	benzaldehyde	0.7770
2,3,4-Trimethylpentane	0.0000	C4 ketone	0.0000
Toluene	0.6061	C6 ketone	0.0000
2,3-Dimethylhexane	0.0000	tolualdehyde ?	5.9897
2-Methylheptane	0.0000	Other C2	1.3744
3-Ethylhexane	0.0000	Other C3	1.4903
n-Octane	0.0000	Other C4	3.4210
Ethylbenzene	0.1778	Other C5	3.6225
m-Xylene	0.2918	Other C6	0.9483
p-Xylene	0.0000	Other C7	1.3786
Styrene	0.0877	Other C8	1.2236
o-Xylene	0.1999	Other C9	3.4121
n-Nonane	0.2391	Other C10	7.1707
i-Propylbenzene	0.0000	Other C11	1.3480
n-Propylbenzene	0.1473		
3-Ethyltoluene	0.2418		

Table 19 - ET-18 Ford diesel tractor (130 hp)

Compound	% by mass	Compound	% by mass
Methane	0.6496	1,3,5-Trimethylbenzene	0.2135
Ethylene	10.7621	2-Ethyltoluene	0.0000
Ethane	0.7990	t-butylbenzene	0.0000
Acetylene	2.3820	1,2,4-Trimethylbenzene	0.9189
Propene	3.3495	i-butylbenzene	0.0000
		s-butylbenzene	0.0000
Propane	0.2630	n-Decane	1.0133
Methylacetylene	0.2070	1,2,3-Trimethylbenzene	0.0000
i-Butane	2.3146	indane	0.2018
methanol	0.0000	1,3-Diethylbenzene	0.0000
i-butylene	0.8008	1,4-Diethylbenzene	0.0000
1-butene	0.9390	n-butylbenzene	0.1950
1,3-Butadiene	0.0000	1,2-Diethylbenzene	0.0000
n-Butane	0.2232	1,4-dimethyl-2-ethylbenzene	0.2929
trans-2-butene	0.3527	1,3-dimethyl-4-ethylbenzene	0.0000
2,2-dimethylpropane	0.0000	1,2-dimethyl-4-ethylbenzene	0.2465
cis-2-butene	0.0000	1,3-dimethyl-2-ethylbenzene	0.2623
ethanol	0.0000	n-undecane	0.0000
i-Pentane	1.2346	1,2,3,5-tetramethylbenzene	0.0000
1-pentene	0.1432	1,2,4,5-tetramethylbenzene	0.0000
n-Pentane	0.4297	OTHER COMPOUNDS	
trans-2-pentene	0.0000	2-propenylbenzene	0.0000
cis-2-pentene	0.0000	1,2-dichlorobenzene	0.0000
2,2-Dimethylbutane	0.0000	2-methylstyrene	0.0000
Cyclopentane	0.0000	1-ethynyl-4-methylbenzene	0.0000
2,3-Dimethylbutane	0.0000	naphthalene	0.0000
2-Methylpentane	1.0783	OXYGENATES	
3-Methylpentane	0.2627	formaldehyde	15.0517
n-Hexane	0.6620	acetaldehyde	5.9778
Methylcyclopentane	0.0000	acetone	4.8042
2,4-Dimethylpentane	0.0000	propanal	1.1632
Benzene	1.4391	MEK	1.2011
Cyclohexane	0.0000	butanal	1.0584
2-Methylhexane	0.0000	2&3-pentanone	0.0000
2,3-Dimethylpentane	0.3102	cyclohexanone	0.3633
3-Methylhexane	0.5641	pentanal	0.4106
2,2,4-trimethylpentane	0.3461	4-methyl-2-pentanone	0.0000
n-Heptane	0.0000	2-methyl-3-pentanone	0.0000
Methylcyclohexane	0.0000	hexanal	2.8549
2,4-Dimethylhexane	0.0000	benzaldehyde	0.9134
2,3,4-Trimethylpentane	0.0000	C4 ketone	1.8030
Toluene	0.8388	C6 ketone	0.0000
2,3-Dimethylhexane	0.0000	tolualdehyde ?	5.4817
2-Methylheptane	0.0000	Other C2	2.4273
3-Ethylhexane	0.0000	Other C3	0.8622
n-Octane	0.1835	Other C4	3.2601
Ethylbenzene	0.2611	Other C5	4.4539
m-Xylene	0.5253	Other C6	0.8910
p-Xylene	0.0000	Other C7	1.8813
Styrene	0.0000	Other C8	1.4151
o-Xylene	0.2914	Other C9	3.0487
n-Nonane	0.4783	Other C10	3.6835
i-Propylbenzene	0.0000	Other C11	0.9809
n-Propylbenzene	0.1765		
3-Ethyltoluene	0.4017		

Table 20 - ET-20 John Deere diesel combine (165 hp)

Compound	% by mass	Compound	% by mass
Methane	2.3511	1,3,5-Trimethylbenzene	0.3283
Ethylene	13.4896	2-Ethyltoluene	0.3506
Ethane	0.2998	t-butylbenzene	0.0527
Acetylene	2.9565	1,2,4-Trimethylbenzene	1.0550
Propene	0.3179	i-butylbenzene	0.1111
		s-butylbenzene	0.1511
Propane	0.5474	n-Decane	0.8525
Methylacetylene	0.1651	1,2,3-Trimethylbenzene	0.3960
i-Butane	0.7757	indane	0.4719
methanol	0.0552	1,3-Diethylbenzene	0.0000
i-butylene	0.5290	1,4-Diethylbenzene	0.3802
1-butene	0.8001	n-butylbenzene	0.2536
1,3-Butadiene	0.0000	1,2-Diethylbenzene	0.0000
		1,4-dimethyl-2-ethylbenzene	0.0000
n-Butane	0.0569	1,3-dimethyl-4-ethylbenzene	0.1748
trans-2-butene	0.1622	1,2-dimethyl-4-ethylbenzene	0.0000
2,2-dimethylpropane	0.0000	1,3-dimethyl-2-ethylbenzene	0.1696
cis-2-butene	0.1184		
ethanol		n-undecane	0.3263
i-Pentane	0.2331	1,2,3,5-tetramethylbenzene	0.0000
1-pentene	0.5349	1,2,4,5-tetramethylbenzene	0.0000
n-Pentane	0.0706	OTHER COMPOUNDS	
trans-2-pentene	0.0000	2-propenylbenzene	0.0000
cis-2-pentene	0.0000	1,2-dichlorobenzene	0.0000
2,2-Dimethylbutane	0.0000	2-methylstyrene	0.0000
Cyclopentane	0.0000	1-ethynyl-4-methylbenzene	0.0000
2,3-Dimethylbutane	0.0198	naphthalene	0.0000
2-Methylpentane	0.0550		
3-Methylpentane	0.0645	OXYGENATES	
		formaldehyde	19.0662
n-Hexane	0.1102	acetaldehyde	7.5917
Methylcyclopentane	0.1094	acetone	6.7692
2,4-Dimethylpentane	0.0263	propanal	1.3627
Benzene	1.7424	MEK	1.0367
Cyclohexane	0.0533	butanal	1.2972
2-Methylhexane	0.0832	2&3-pentanone	0.0000
2,3-Dimethylpentane	0.0489	cyclohexanone	0.0000
3-Methylhexane	0.3954	pentanal	0.0000
2,2,4-trimethylpentane	0.5482	4-methyl-2-pentanone	0.0000
		2-methyl-3-pentanone	0.0000
n-Heptane	0.1385	hexanal	4.1876
Methylcyclohexane	0.0471	benzaldehyde	1.0349
2,4-Dimethylhexane	0.0599	C4 ketone	1.6520
2,3,4-Trimethylpentane	0.0352	C6 ketone	0.0000
Toluene	1.2344	tolualdehyde ?	4.7754
2,3-Dimethylhexane	0.0178		
2-Methylheptane	0.1269	Other C2	1.0122
3-Ethylhexane	0.1601	Other C3	0.1637
		Other C4	0.5919
n-Octane	0.2842	Other C5	0.9413
Ethylbenzene	0.3538	Other C6	1.0008
m-Xylene	0.7920	Other C7	1.4656
p-Xylene	0.3141	Other C8	1.9592
Styrene	0.0769	Other C9	3.7201
o-Xylene	0.4366	Other C10	3.6434
		Other C11	0.3027
n-Nonane	0.3740		
i-Propylbenzene	0.0000		
n-Propylbenzene	0.1158		
3-Ethyltoluene	0.0647		

Table 21 - ET-21 Sperry diesel swather (43 hp)

Compound	% by mass	Compound	% by mass
Methane	6.0623	1,3,5-Trimethylbenzene	0.1164
Ethylene	17.8231	2-Ethyltoluene	0.0951
Ethane	2.1911	t-butylbenzene	0.0000
Acetylene	12.7914	1,2,4-Trimethylbenzene	0.0000
Propene	6.0011	i-butylbenzene	0.0000
		s-butylbenzene	0.0000
Propane	0.2283	n-Decane	0.0000
Methylacetylene	2.0342	1,2,3-Trimethylbenzene	0.0000
i-Butane	0.0890	indane	0.0000
methanol	0.1147	1,3-Diethylbenzene	0.0000
i-butylene	1.7400	1,4-Diethylbenzene	0.0000
1-butene	0.9315	n-butylbenzene	0.0000
1,3-Butadiene	1.4333	1,2-Diethylbenzene	0.0000
		1,4-dimethyl-2-ethylbenzene	0.0000
n-Butane	0.2881	1,3-dimethyl-4-ethylbenzene	0.0000
trans-2-butene	0.3346	1,2-dimethyl-4-ethylbenzene	0.0000
2,2-dimethylpropane	0.0000	1,3-dimethyl-2-ethylbenzene	0.0000
cis-2-butene	0.2670	0.0000	
ethanol	0.0646	n-undecane	0.0000
i-Pentane	0.6177	1,2,3,5-tetramethylbenzene	0.0000
1-pentene	0.2039	1,2,4,5-tetramethylbenzene	0.0000
		OTHER COMPOUNDS	
n-Pentane	0.4489	2-propenylbenzene	0.0000
trans-2-pentene	0.0227	1,2-dichlorobenzene	0.0000
cis-2-pentene	0.1063	2-methylstyrene	0.0000
2,2-Dimethylbutane	0.0000	1-ethynyl-4-methylbenzene	0.0000
Cyclopentane	0.0658	naphthalene	0.0000
2,3-Dimethylbutane	0.1526	OXYGENATES	
2-Methylpentane	0.6070	formaldehyde	6.7659
3-Methylpentane	0.3943	acetaldehyde	3.3328
		acetone	6.6774
n-Hexane	0.2909	propanal	0.0000
Methylcyclopentane	0.4260	MEK	2.2102
2,4-Dimethylpentane	0.0906	butanal	0.0000
Benzene	6.2867	2&3-pentanone	0.0000
Cyclohexane	0.0000	cyclohexanone	0.0000
2-Methylhexane	0.2707	pentanal	0.0000
2,3-Dimethylpentane	0.1185	4-methyl-2-pentanone	0.0000
3-Methylhexane	0.2685	2-methyl-3-pentanone	0.0000
2,2,4-trimethylpentane	0.1212	hexanal	2.2387
		benzaldehyde	1.4735
n-Heptane	0.1620	C4 ketone	0.0000
Methylcyclohexane	0.1255	C6 ketone	0.0000
2,4-Dimethylhexane	0.0836	tolualdehyde ?	0.0000
2,3,4-Trimethylpentane	0.0835	Other C2	0.7262
Toluene	5.6894	Other C3	0.0000
2,3-Dimethylhexane	0.0401	Other C4	1.2842
2-Methylheptane	0.1009	Other C5	0.7189
3-Ethylhexane	0.1053	Other C6	0.8008
		Other C7	0.2366
n-Octane	0.0473	Other C8	0.1194
Ethylbenzene	0.8270	Other C9	0.4981
m-Xylene	1.7539	Other C10	0.0000
p-Xylene	0.0000	Other C11	0.0000
Styrene	0.0000		
o-Xylene	0.7453		
n-Nonane	0.0554		
i-Propylbenzene	0.0000		
n-Propylbenzene	0.0000		
3-Ethyltoluene	0.0000		

Table 22 - ET-23 Case diesel tractor (44 hp)

Compound	% by mass	Compound	% by mass
Methane	0.9658	1,3,5-Trimethylbenzene	0.0797
Ethylene	20.8827	2-Ethyltoluene	0.0000
Ethane	0.3960	t-butylbenzene	0.0000
Acetylene	3.9332	1,2,4-Trimethylbenzene	0.1932
Propene	0.7744	i-butylbenzene	0.0318
Propane	0.0000	s-butylbenzene	0.0447
Methylacetylene	0.1703	n-Decane	0.1446
i-Butane	0.7207	1,2,3-Trimethylbenzene	0.0464
methanol	0.0000	indane	0.0000
i-butylene	1.6485	1,3-Diethylbenzene	0.0000
1-butene	0.0000	1,4-Diethylbenzene	0.0000
1,3-Butadiene	0.0164	n-butylbenzene	0.0203
n-Butane	0.0150	1,2-Diethylbenzene	0.0000
trans-2-butene	0.2216	1,4-dimethyl-2-ethylbenzene	0.0000
2,2-dimethylpropane	0.0000	1,3-dimethyl-4-ethylbenzene	0.0000
cis-2-butene	0.1659	1,2-dimethyl-4-ethylbenzene	0.0000
ethanol	0.0000	1,3-dimethyl-2-ethylbenzene	0.0000
i-Pentane	0.0751	n-undecane	0.0000
1-pentene	0.6797	1,2,3,5-tetramethylbenzene	0.0000
n-Pentane	0.0279	1,2,4,5-tetramethylbenzene	0.0000
trans-2-pentene	0.1301	OTHER COMPOUNDS	
cis-2-pentene	0.0191	2-propenylbenzene	0.0000
2,2-Dimethylbutane	0.0000	1,2-dichlorobenzene	0.0000
Cyclopentane	0.0000	2-methylstyrene	0.3801
2,3-Dimethylbutane	0.0263	1-ethynyl-4-methylbenzene	0.0000
2-Methylpentane	0.0259	naphthalene	0.6822
3-Methylpentane	0.0223	OXYGENATES	
n-Hexane	0.0230	formaldehyde	21.7915
Methylcyclopentane	0.0285	acetaldehyde	8.9527
2,4-Dimethylpentane	0.0000	acetone	6.4993
Benzene	1.4855	propanal	1.7765
Cyclohexane	0.0000	MEK	1.0529
2-Methylhexane	0.0220	butanal	0.0000
2,3-Dimethylpentane	0.0118	2&3-pentanone	0.0000
3-Methylhexane	0.1963	cyclohexanone	0.0000
2,2,4-trimethylpentane	0.3748	pentanal	0.0000
n-Heptane	0.0127	4-methyl-2-pentanone	0.0000
Methylcyclohexane	0.0326	2-methyl-3-pentanone	0.0000
2,4-Dimethylhexane	0.0533	hexanal	3.2319
2,3,4-Trimethylpentane	0.0000	benzaldehyde	1.3927
Toluene	0.8425	C4 ketone	1.8996
2,3-Dimethylhexane	0.0000	C6 ketone	7.1948
2-Methylheptane	0.0000	tolualdehyde ?	0.0000
3-Ethylhexane	0.0465	Other C2	0.1393
n-Octane	0.1469	Other C3	0.0000
Ethylbenzene	0.1659	Other C4	1.5567
m-Xylene	0.3180	Other C5	2.0508
p-Xylene	0.1325	Other C6	1.3212
Styrene	0.0623	Other C7	1.3213
o-Xylene	0.1721	Other C8	1.2635
n-Nonane	0.1454	Other C9	1.1966
i-Propylbenzene	0.0311	Other C10	0.2890
n-Propylbenzene	0.0914	Other C11	0.0000
3-Ethyltoluene	0.1346		

Table 23 - ET-25 John Deere diesel tractor (33.4 hp)

Compound	% by mass
Methane	4.4381
Ethylene	15.6962
Ethane	0.1775
Acetylene	4.2902
Propene	0.6955
Propane	0.1451
Methylacetylene	0.1794
i-Butane	0.6161
i-butylene	0.9835
1-butene	0.0187
1,3-Butadiene	0.0206
n-Butane	0.0652
trans-2-butene	0.0881
2,2-dimethylpropane	0.0000
cis-2-butene	0.0726
i-Pentane	0.0501
1-pentene	0.2741
n-Pentane	0.0860
trans-2-pentene	0.0000
cis-2-pentene	0.0277
2,2-Dimethylbutane	0.0000
Cyclopentane	0.0000
2,3-Dimethylbutane	0.0000
2-Methylpentane	0.1229
3-Methylpentane	0.0238
n-Hexane	0.0215
Methylcyclopentane	0.0000
2,4-Dimethylpentane	0.0000
Benzene	1.2672
Cyclohexane	0.0297
2-Methylhexane	0.1650
2,3-Dimethylpentane	0.0000
3-Methylhexane	0.1926
2,2,4-trimethylpentane	0.2100
n-Heptane	0.0288
Methylcyclohexane	0.0712
2,4-Dimethylhexane	0.0000
2,3,4-Trimethylpentane	0.0000
Toluene	0.6480
2,3-Dimethylhexane	0.0000
2-Methylheptane	0.0342
3-Ethylhexane	0.0000
n-Octane	0.0457
Ethylbenzene	0.1159
m-Xylene	0.3238
p-Xylene	0.0000
Styrene	0.0336
o-Xylene	0.1624
n-Nonane	0.0533
i-Propylbenzene	0.0000
n-Propylbenzene	0.0787
3-Ethyltoluene	0.2571

Compound	% by mass
1,3,5-Trimethylbenzene	0.1452
2-Ethyltoluene	0.1286
t-butylbenzene	0.0000
1,2,4-Trimethylbenzene	0.4504
i-butylbenzene	0.0000
s-butylbenzene	0.0000
n-Decane	0.1274
1,2,3-Trimethylbenzene	0.0391
indane	0.0000
1,3-Diethylbenzene	0.0550
1,4-Diethylbenzene	0.1101
n-butylbenzene	0.0000
1,2-Diethylbenzene	0.0890
1,4-dimethyl-2-ethylbenzene	0.0000
1,3-dimethyl-4-ethylbenzene	0.0000
1,2-dimethyl-4-ethylbenzene	0.0000
1,3-dimethyl-2-ethylbenzene	0.0000
n-undecane	0.0000
1,2,3,5-tetramethylbenzene	0.0000
1,2,4,5-tetramethylbenzene	0.0000
OTHER COMPOUNDS	
2-propenylbenzene	0.0000
1,2-dichlorobenzene	0.0000
2-methylstyrene	0.0000
1-ethynyl-4-methylbenzene	0.0000
naphthalene	0.0000
OXYGENATES	
formaldehyde	16.1934
acetaldehyde	11.5133
acetone	11.2229
propanal	1.2555
MEK	1.9316
butanal	8.1996
2&3-pentanone	0.0000
cyclohexanone	0.0000
pentanal	0.0000
4-methyl-2-pentanone	0.0000
2-methyl-3-pentanone	0.0000
hexanal	5.3360
benzaldehyde	0.0000
C4 ketone	3.3301
C6 ketone	0.0000
tolualdehyde ?	4.2414
Other C2	0.0884
Other C3	0.0000
Other C4	0.4100
Other C5	0.6274
Other C6	0.3844
Other C7	0.9044
Other C8	0.2253
Other C9	0.5853
Other C10	0.5961
Other C11	0.0000

Table 24 - ET-26 Caterpillar diesel tractor (105 hp)

Compound	% by mass
Methane	14.5098
Ethylene	10.1569
Ethane	0.1403
Acetylene	1.9637
Propene	0.8381
Propane	0.1360
Methylacetylene	0.0464
i-Butane	0.7237
methanol	0.0671
i-butylene	0.0820
1-butene	0.1595
1,3-Butadiene	0.0000
n-Butane	0.0214
trans-2-butene	0.0000
2,2-dimethylpropane	0.0000
cis-2-butene	0.0000
ethanol	0.0000
i-Pentane	0.6018
1-pentene	0.0419
n-Pentane	0.0411
trans-2-pentene	0.0304
cis-2-pentene	0.0243
2,2-Dimethylbutane	0.2835
Cyclopentane	0.0000
2,3-Dimethylbutane	0.0000
2-Methylpentane	0.0909
3-Methylpentane	0.0562
n-Hexane	0.0493
Methylcyclopentane	0.0449
2,4-Dimethylpentane	0.0000
Benzene	0.9948
Cyclohexane	0.0000
2-Methylhexane	0.0298
2,3-Dimethylpentane	0.0308
3-Methylhexane	0.2412
2,2,4-trimethylpentane	0.1487
n-Heptane	0.0648
Methylcyclohexane	0.1118
2,4-Dimethylhexane	0.0332
2,3,4-Trimethylpentane	0.0000
Toluene	0.6336
2,3-Dimethylhexane	0.0000
2-Methylheptane	0.0497
3-Ethylhexane	0.0628
n-Octane	0.1820
Ethylbenzene	0.2080
m-Xylene	0.4609
p-Xylene	0.0000
Styrene	0.0000
o-Xylene	0.2466
n-Nonane	0.3077
i-Propylbenzene	0.0362
n-Propylbenzene	0.1594
3-Ethyltoluene	0.3243

Compound	% by mass
1,3,5-Trimethylbenzene	0.2135
2-Ethyltoluene	0.2403
t-butylbenzene	0.0000
1,2,4-Trimethylbenzene	0.5648
i-butylbenzene	0.0867
s-butylbenzene	0.1194
n-Decane	0.7533
1,2,3-Trimethylbenzene	0.1203
indane	0.0000
1,3-Diethylbenzene	0.2251
1,4-Diethylbenzene	0.2782
n-butylbenzene	0.1718
1,2-Diethylbenzene	0.2827
1,4-dimethyl-2-ethylbenzene	0.1247
1,3-dimethyl-4-ethylbenzene	0.1691
1,2-dimethyl-4-ethylbenzene	0.1344
1,3-dimethyl-2-ethylbenzene	0.2097
n-undecane	0.0000
1,2,3,5-tetramethylbenzene	0.0000
1,2,4,5-tetramethylbenzene	0.0000
OTHER COMPOUNDS	
2-propenylbenzene	0.0000
1,2-dichlorobenzene	0.0000
2-methylstyrene	0.0000
1-ethynyl-4-methylbenzene	0.0000
naphthalene	0.0000
OXYGENATES	
formaldehyde	11.8394
acetaldehyde	9.3346
acetone	12.1517
propanal	0.0000
MEK	2.1803
butanal	2.1021
2&3-pentanone	0.0000
cyclohexanone	0.0000
pentanal	0.0000
4-methyl-2-pentanone	0.0000
2-methyl-3-pentanone	0.0000
hexanal	6.5379
benzaldehyde	0.0000
C4 ketone	5.3008
C6 ketone	0.0000
tolualdehyde ?	0.0000
Other C2	0.4278
Other C3	0.1190
Other C4	0.8926
Other C5	0.9351
Other C6	0.3810
Other C7	1.8863
Other C8	1.4887
Other C9	2.2931
Other C10	2.7115
Other C11	1.2882

Table 25 - ET-27 John Deere diesel tractor (150 hp)

Compound	% by mass
Methane	2.8627
Ethylene	14.3604
Ethane	0.3206
Acetylene	3.3971
Propene	5.1036
Propane	0.1650
Methylacetylene	0.6381
i-Butane	2.0247
methanol	0.0000
i-butylene	0.8301
1-butene	1.2954
1,3-Butadiene	0.0483
n-Butane	0.1612
trans-2-butene	0.0497
2,2-dimethylpropane	0.0000
cis-2-butene	0.0000
ethanol	0.0000
i-Pentane	0.7649
1-pentene	0.1995
n-Pentane	0.0655
trans-2-pentene	0.1353
cis-2-pentene	0.0624
2,2-Dimethylbutane	0.2018
Cyclopentane	0.0310
2,3-Dimethylbutane	0.0293
2-Methylpentane	0.1791
3-Methylpentane	0.0929
n-Hexane	0.0945
Methylcyclopentane	0.1203
2,4-Dimethylpentane	0.0309
Benzene	1.7285
Cyclohexane	0.0214
2-Methylhexane	0.1080
2,3-Dimethylpentane	0.0607
3-Methylhexane	0.3219
2,2,4-trimethylpentane	0.3230
n-Heptane	0.1341
Methylcyclohexane	0.1577
2,4-Dimethylhexane	0.0583
2,3,4-Trimethylpentane	0.0000
Toluene	1.2773
2,3-Dimethylhexane	0.0319
2-Methylheptane	0.1449
3-Ethylhexane	0.1048
n-Octane	0.2243
Ethylbenzene	0.3284
m-Xylene	0.4226
p-Xylene	0.3128
Styrene	0.2070
o-Xylene	0.4198
n-Nonane	0.1888
i-Propylbenzene	0.0490
n-Propylbenzene	0.2117
3-Ethyltoluene	0.5515

Compound	% by mass
1,3,5-Trimethylbenzene	0.3088
2-Ethyltoluene	0.2892
t-butylbenzene	0.0000
1,2,4-Trimethylbenzene	1.0521
i-butylbenzene	0.0687
s-butylbenzene	0.0908
n-Decane	0.3224
1,2,3-Trimethylbenzene	0.3564
indane	0.0000
1,3-Diethylbenzene	0.1559
1,4-Diethylbenzene	0.3130
n-butylbenzene	0.0000
1,2-Diethylbenzene	0.3164
1,4-dimethyl-2-ethylbenzene	0.0899
1,3-dimethyl-4-ethylbenzene	0.1802
1,2-dimethyl-4-ethylbenzene	0.0869
1,3-dimethyl-2-ethylbenzene	0.2392
n-undecane	0.0000
1,2,3,5-tetramethylbenzene	0.0000
1,2,4,5-tetramethylbenzene	0.0000
OTHER COMPOUNDS	
2-propenylbenzene	0.0000
1,2-dichlorobenzene	0.0000
2-methylstyrene	0.0000
1-ethynyl-4-methylbenzene	0.0000
naphthalene	0.0000
OXYGENATES	
formaldehyde	13.0769
acetaldehyde	6.5077
acetone	8.4189
propanal	1.0921
MEK	1.5153
butanal	1.3352
2&3-pentanone	0.0000
cyclohexanone	0.0000
pentanal	0.0000
4-methyl-2-pentanone	0.0000
2-methyl-3-pentanone	0.0000
hexanal	3.4991
benzaldehyde	0.0000
C4 ketone	0.0000
C6 ketone	0.0000
tolualdehyde ?	2.0634
Other C2	0.0515
Other C3	1.0779
Other C4	3.3793
Other C5	2.5560
Other C6	1.4104
Other C7	1.7835
Other C8	2.0148
Other C9	2.4469
Other C10	2.6487
Other C11	0.5996

I. Discussion

1. Aldehyde Results

To investigate the efficiency of the aldehyde sampling system, separate analysis of the two series impingers used in the sampling train was performed. The diluted exhaust from a Snapper 21500C lawnmower was drawn through two impingers in series, at a flow of 432 mL/min for a period of 20.0 minutes. The contents of each impinger was analyzed separately. Table 26 shows the results of this study. As this Table shows, aldehydes and ketones are collected very efficiently, with 87 to 100% of 14 compounds being retained in the first impinger. While two impingers were used in all exhaust sampling tests, impinger contents were usually pooled into a single sample, to minimize analytical costs.

In order to explore analytical variability, sample ET-18 was analyzed in duplicate. Results for this diesel exhaust sample are shown in Table 27. Replicate samples exhibited excellent agreement, with average deviations from the mean in the range of 0.1 to 2.7% for the 11 compounds detected.

Sampling variability was addressed by a series of tests using a Swirl Magic III 732053 lawnmower. Two consecutive 20.0 minute runs were performed on this engine. Table 28 shows that the sampling variability ranges from 0.5 to 13% (average 4%), for the 13 carbonyl compounds detected.

Table 26- Impinger Breakthrough Study

(ET-1)

Conc. in $\mu\text{g}/\text{m}^3$			
Component	imp #1	imp #2	amount in #1
formaldehyde	985.6	42.16	95.90%
acetaldehyde	4607.74	214.49	95.55%
acetone	1845.54	229.25	88.95%
propanal	1435.53	30.47	97.92%
MEK	1245.15	59.79	95.42%
butanal	1105.31	43.27	96.23%
2&3-pentanone	410.22	0	100.00%
cyclohexanone	262.76	0	100.00%
pentanal	504.93	0	100.00%
4-methyl- 2-pentanone	3833.5	362.97	91.35%
4-methyl- 3-pentanone	320.86	0	100.00%
hexanal	2017.93	294.59	87.26%
benzaldehyde	1628.26	56.05	96.67%
unknown C4 ketone	1089.3	0	100.00%
=====			
AVERAGE			96.09%
=====			

$$\text{deviation} = \frac{\text{observed}}{\text{average}} \times 100$$

Table 27 - Analytical Precision (ET-18)

Component	Conc. in $\mu\text{g}/\text{m}^3$		ave. dev. from mean
	run #1	run #2	
formaldehyde	4558.01	4569.231	0.12%
acetaldehyde	1810.21	1815.06	0.13%
acetone	1454.82	1460.01	0.18%
propanal	352.23	356.23	0.56%
MEK	363.71	356.83	0.95%
butanal	320.51	323.55	0.47%
pentanal	124.34	131.27	2.71%
hexanal	864.53	880.48	0.91%
benzaldehyde	276.59	278.8	0.40%
unknown C4 ketone	545.98	541.06	0.45%
unknown C7 aldehyde	1660	1686	0.78%
=====			
AVERAGE			0.70%
=====			

$$\text{deviation} = \frac{\text{observed}}{\text{average}} \times 100$$

Table 28- Sampling Precision (ET-10 and ET-11)

Component	Conc. in mg/m ³		ave. dev. from mean
	run #1	run #2	
formaldehyde	5931.21	5544.77	3.37%
acetaldehyde	1264.07	1180.12	3.43%
acetone	1217.22	1204.02	0.55%
propanal	278.11	237.26	7.93%
MEK	333.14	308.81	3.79%
butanal	111.04	85.36	13.08%
cyclohexanone	100.16	95.67	2.29%
4-methyl- 2-pentanone	520.58	558.67	3.53%
4-methyl- 3-pentanone	149.42	128.93	7.36%
hexanal	166.85	168.49	0.49%
benzaldehyde	312.22	309.5	0.44%
unknown C4 ketone	211.96	225.27	3.04%
unknown C6 ketone	931.03	953.35	1.18%
=====			
AVERAGE			3.88%
=====			

$$\text{deviation} = \frac{\text{observed}}{\text{average}} \times 100$$

2. Hydrocarbon Replicate Samples

To assess variability introduced by the exhaust sampling process, several duplicate engine tests were conducted. Table 29 shows the results of duplicate samples taken from a 3 HP lawnmower. Similarly, Table 30 shows the results of duplicates taken from a Ford diesel tractor. The average variability by species was about 30 % relative to the mean.

3 Aldehyde and Ketone Concentrations

Table 31 shows the contribution of formaldehyde as a fraction of total aldehydes as well as of aldehydes plus ketones. For the engines tested, roughly 50 % of the total aldehyde content was attributed to formaldehyde, in agreement with previous studies. Results from two of the two-stroke engines (ET-1 and ET-4) showed very low aldehyde percentages. These results were due to the very high non-aldehyde components in the exhaust of these engines. Actual aldehyde concentrations (expressed as micrograms per cubic meter) in diluted exhaust from these engines was comparable to that in other Category 2 sources.

Table 32 shows a comparison of formaldehyde concentrations for Category 2 and three sources. The average value for formaldehyde percentage in these sources was found to be around 1 %. For Category 3 sources, lower values of non-carbonyl hydrocarbons produced apparently elevated values for formaldehyde, with an average of around 15 %.

4. Hydrocarbon Concentrations

As discussed earlier, separate analytical results from methane, hydrocarbon and aldehyde analyses were collected into a combined data set for each engine. The major components (acetylene, ethylene, xylenes, toluene, trimethyl benzenes) were present at values comparable to other studies^{11, 12}.

However, the magnitude of the aldehyde contribution to the total hydrocarbon content was expected to be in the range of 8 to 14 %. In some of the samples taken, aldehydes were significantly higher than this. The effect is particularly obvious in the diesel exhaust tests (ET-17 through ET-27), which showed low values for total hydrocarbon. It should be noted that these high aldehyde values were not due to anomalously high aldehyde concentrations. Indeed, the aldehyde concentrations in the diluted diesel exhaust were comparable to those obtained for the other engines in this study. However, the total hydrocarbon content of these samples was significantly lower than the non-diesel engines. Thus, the aldehydes contributed a larger percentage of the total sampled hydrocarbons for these engines. A large fraction of the total hydrocarbon mass emitted by diesel engines is associated with the particulate phase. No particulate samples were taken for any engine in this study. It is therefore likely that the hydrocarbon speciation for the diesel engines tested would be significantly different if high molecular weight, particulate-associated hydrocarbons were included in the total.

The results for the analysis of the XAD-2 extracts taken from the diesel exhaust samples were all below the detection limit for the method. Taking a value of 2 micrograms for the lower limit of detection, this means that the heavy gas phase hydrocarbons were present at values of less than one percent of the total exhaust hydrocarbon values measured by GC-FID. Mention should again be made of the fact that many of these compounds are in, or adsorbed onto the particulate phase of the exhaust, which was not sampled.

Consistent with the original Request for Proposal, results have been summarized for Category 2 and Category 3 Sources, as shown in Tables 32 and 33.

Examination of the overall results revealed that twelve compounds were responsible for roughly 50 % of the total hydrocarbon mass for all engines tested. In a few cases, these 12 components accounted for nearly 70 % of all hydrocarbons. These major components were: methane, ethylene, acetylene, propene, isopentane, benzene, toluene, m-xylene, p-xylene, o-xylene, 1,2,4-trimethylbenzene and formaldehyde. Graphs of these profiles for Category 2 and Category 3 sources are shown in Figures 20 and 21.

Table 29 - Engine Test Duplicate

Compound	ET-10	ET-11	differenc % relative			differenc % relative				
			absolute	to mean		absolute	to mean	absolute	to mean	
Methane	12.3172	8.4401	3.88	37.36	1,3,5-Trimethylbenze	0.7360	0.8014	0.07	8.51	
Ethylene	7.4521	7.3841	0.07	0.92	2-Ethyltoluene	0.6275	0.8961	0.27	35.26	
Ethane	0.9531	0.9230	0.03	3.20	t-butylbenzene	0.0000	0.0000	0.00		
Acetylene	7.0708	9.4804	2.41	29.12	1,2,4-Trimethylbenze	2.0418	2.9129	0.87	35.16	
Propene	3.4981	3.7195	0.22	6.13	i-butylbenzene	0.0339	0.0444	0.01	26.91	
					s-butylbenzene	0.0437	0.0553	0.01	23.44	
Propane	0.2706	0.1459	0.12	59.85						
Methylacetylene	0.6787	0.4185	0.26	47.44	n-Decane	0.1156	0.1350	0.02	15.52	
i-Butane	0.2626	0.2562	0.01	2.46	1,2,3-Trimethylbenze	0.2962	0.5743	0.28	63.89	
methanol	0.1086	0.0809	0.03	29.28	indane	0.1484	0.5651	0.42	116.83	
i-butylene	1.4839	1.3373	0.15	10.39	1,3-Diethylbenzene	0.0000	0.0000	0.00		
1-butene	0.8090	0.7917	0.02	2.16	1,4-Diethylbenzene	0.1379	0.4122	0.27	99.72	
1,3-Butadiene	1.3788	1.2842	0.09	7.10	n-butylbenzene	0.0533	0.6659	0.61	170.36	
					1,2-Diethylbenzene	0.0000	0.0000	0.00		
n-Butane	0.9386	0.8983	0.04	4.39	1,4-dimethyl-2-ethyl	0.0000	0.3438	0.34		
trans-2-butene	0.3857	0.3641	0.02	5.76	1,3-dimethyl-4-ethyl	0.0628	0.3455	0.28	138.50	
2,2-dimethylpropane	0.0000	0.0000	0.00		1,2-dimethyl-4-ethyl	0.0000	0.4309	0.43		
cis-2-butene	0.3070	0.2881	0.02	6.35	1,3-dimethyl-2-ethyl	0.0606	0.1788	0.12	98.78	
ethanol	0.0000	0.0534	0.05							
i-Pentane	3.6077	3.4600	0.15	4.18	n-undecane	0.0000	0.0943	0.09		
1-pentene	0.2905	0.2781	0.01	4.38	1,2,3,5-tetramethylb	0.0000	0.0000	0.00		
					1,2,4,5-tetramethylb	0.0000	0.1817	0.18		
n-Pentane	1.2466	1.1572	0.09	7.44						
trans-2-pentene	0.5940	0.5304	0.06	11.31	OTHER COMPOUNDS					
cis-2-pentene	0.2472	0.2357	0.01	4.77						
2,2-Dimethylbutane	0.1606	0.6045	0.44	116.04	2-propenylbenzene	0.0000	0.0000	0.00		
Cyclopentane	0.3988	0.1985	0.20	67.08	1,2-dichlorobenzene	0.0000	0.0000	0.00		
2,3-Dimethylbutane	0.0460	0.3842	0.34	157.19	2-methylstyrene	0.6583	0.0000	0.66		
2-Methylpentane	1.6579	1.5791	0.08	4.87	1-ethynyl-4-methylbe	0.0081	0.0000	0.01		
3-Methylpentane	1.0483	0.6810	0.37	42.49	naphthalene	0.7971	0.0000	0.80		
n-Hexane	0.8096	0.7480	0.06	7.91	OXYGENATES					
Methylcyclopentane	1.2432	1.1765	0.07	5.52						
2,4-Dimethylpentane	0.2691	0.2616	0.01	2.83	formaldehyde	0.8210	0.6614	0.16	21.53	
Benzene	4.8613	4.1764	0.68	15.16	acetaldehyde	0.1750	0.1408	0.03	21.66	
Cyclohexane	0.0345	0.0337	0.00	2.25	acetone	0.1685	0.1436	0.02	15.93	
2-Methylhexane	0.7433	0.7122	0.03	4.28	propanal	0.0385	0.0283	0.01	30.52	
2,3-Dimethylpentane	0.2946	0.2901	0.00	1.53	MEK	0.0461	0.0368	0.01	22.37	
3-Methylhexane	0.7294	0.6973	0.03	4.51	butanal	0.0154	0.0102	0.01	40.61	
2,2,4-trimethylpenta	0.6709	0.6621	0.01	1.32	2&3-pentanone	0.0000	0.0000	0.00		
					cyclohexanone	0.0139	0.0114	0.00	19.40	
n-Heptane	0.5411	0.0412	0.50	171.70	pentanal	0.0000	0.0000	0.00		
Methylcyclohexane	0.4471	0.4283	0.02	4.30	4-methyl-2-pentanone	0.0721	0.0666	0.01	7.81	
2,4-Dimethylhexane	0.2116	0.2046	0.01	3.37	2-methyl-3-pentanone	0.0207	0.0154	0.01	29.41	
2,3,4-Trimethylpenta	0.2854	0.2839	0.00	0.54	hexanal	0.0231	0.0201	0.00	13.88	
Toluene	7.7897	6.7268	1.06	14.64	benzaldehyde	0.0000	0.0000	0.00		
2,3-Dimethylhexane	0.1180	0.1063	0.01	10.45	C4 ketone	0.0293	0.0269	0.00	8.78	
2-Methylheptane	0.3292	0.3130	0.02	5.07	C6 ketone	0.1289	0.1137	0.02	12.49	
3-Ethylhexane	0.3205	0.3066	0.01	4.42	tolualdehyde ?	0.0000	0.0000	0.00		
n-Octane	0.2720	0.2526	0.02	7.38	Other C2	1.3656	2.9143	1.55	72.37	
Ethylbenzene	1.7420	1.5863	0.16	9.36	Other C3	0.1069	0.0906	0.02	16.47	
m-Xylene	4.4973	4.0986	0.40	9.28	Other C4	1.2393	1.2379	0.00	0.12	
p-Xylene	1.4996	1.3619	0.14	9.62	Other C5	2.8349	2.3149	0.52	20.20	
Styrene	0.0000	0.5943	0.59		Other C6	2.5428	2.6658	0.12	4.72	
o-Xylene	2.0792	1.9286	0.15	7.51	Other C7	1.6126	2.1598	0.55	29.01	
					Other C8	1.7489	1.1480	0.60	41.48	
n-Nonane	0.1565	0.1366	0.02	13.54	Other C9	1.3687	1.6944	0.33	21.27	
i-Propylbenzene	0.0762	0.0750	0.00	1.58	Other C10	0.5496	1.3004	0.75	81.17	
n-Propylbenzene	0.3392	0.3598	0.02	5.90	Other C11	0.0000	0.2114	0.21		
3-Ethyltoluene	1.6844	1.8133	0.13	7.37						
AVERAGE										
(non-zero values)								0.23	27.85	

Table 30 - Engine Test Duplicate

Compound	ET-17	ET-18	differenc % relative					differenc % relative	
			absolute	to mean				absolute	to mean
Methane	0.8140	0.6496	0.16	22.46	1,3,5-Trimethylbenze	0.1442	0.2135	0.07	38.71
Ethylene	11.7762	10.7621	1.01	9.00	2-Ethyltoluene	0.0000	0.0000	0.00	
Ethane	0.1899	0.7990	0.61	123.18	t-butylbenzene	0.0000	0.0000	0.00	
Acetylene	2.3064	2.3820	0.08	3.22	1,2,4-Trimethylbenze	0.0000	0.9189	0.92	
Propene	3.6814	3.3495	0.33	9.44	i-butylbenzene	0.7139	0.0000	0.71	
					s-butylbenzene	0.0000	0.0000	0.00	
Propane	0.0000	0.2630	0.26						
Methylacetylene	0.2861	0.2070	0.08	32.07	n-Decane	1.0099	1.0133	0.00	0.34
i-Butane	2.5084	2.3146	0.19	8.04	1,2,3-Trimethylbenze	0.0000	0.0000	0.00	
methanol	0.0000	0.0000	0.00		indane	0.8259	0.2018	0.62	121.45
i-butylene	0.7552	0.8008	0.05	5.86	1,3-Diethylbenzene	0.0000	0.0000	0.00	
1-butene	1.1784	0.9390	0.24	22.62	1,4-Diethylbenzene	0.0000	0.0000	0.00	
1,3-Butadiene	0.0000	0.0000	0.00		n-butylbenzene	0.3727	0.1950	0.18	62.60
					1,2-Diethylbenzene	0.0000	0.0000	0.00	
n-Butane	0.0000	0.2232	0.22		1,4-dimethyl-2-ethyl	0.5263	0.2929	0.23	57.00
trans-2-butene	0.3517	0.3527	0.00	0.28	1,3-dimethyl-4-ethyl	0.2640	0.0000	0.26	
2,2-dimethylpropane	0.0000	0.0000	0.00		1,2-dimethyl-4-ethyl	0.4082	0.2465	0.16	49.41
cis-2-butene	0.1310	0.0000	0.13		1,3-dimethyl-2-ethyl	0.3939	0.2623	0.13	40.13
ethanol	0.0000	0.0000	0.00						
i-Pentane	1.2323	1.2346	0.00	0.18	n-undecane	1.7610	0.0000	1.76	
1-pentene	0.5115	0.1432	0.37	112.53	1,2,3,5-tetramethylb	0.2863	0.0000	0.29	
					1,2,4,5-tetramethylb	0.3500	0.0000	0.35	
n-Pentane	0.2314	0.4297	0.20	60.01					
trans-2-pentene	0.0000	0.0000	0.00		OTHER COMPOUNDS				
cis-2-pentene	0.0000	0.0000	0.00		2-propenylbenzene	0.0000	0.0000	0.00	
2,2-Dimethylbutane	0.0000	0.0000	0.00		1,2-dichlorobenzene	0.0000	0.0000	0.00	
Cyclopentane	0.0000	0.0000	0.00		2-methylstyrene	0.0000	0.0000	0.00	
2,3-Dimethylbutane	0.0000	0.0000	0.00		1-ethynyl-4-methylbe	0.0000	0.0000	0.00	
2-Methylpentane	0.9766	1.0783	0.10	9.90	naphthalene	0.0000	0.0000	0.00	
3-Methylpentane	0.0000	0.2627	0.26						
					OXYGENATES				
n-Hexane	0.0000	0.6620	0.66		formaldehyde	13.8609	15.0517	1.19	8.24
Methylcyclopentane	0.4614	0.0000	0.46		acetaldehyde	5.5769	5.9778	0.40	6.94
2,4-Dimethylpentane	0.0000	0.0000	0.00		acetone	3.4737	4.8042	1.33	32.14
Benzene	1.0546	1.4391	0.38	30.83	propanal	1.0996	1.1632	0.06	5.62
Cyclohexane	0.1047	0.0000	0.10		MEK	0.6891	1.2011	0.51	54.17
2-Methylhexane	0.2441	0.0000	0.24		butanal	0.9395	1.0584	0.12	11.90
2,3-Dimethylpentane	0.0000	0.3102	0.31		2&3-pentanone	0.0000	0.0000	0.00	
3-Methylhexane	0.6024	0.5641	0.04	6.57	cyclohexanone	0.4923	0.3633	0.13	30.15
2,2,4-trimethylpenta	0.3088	0.3461	0.04	11.40	pentanal	0.4698	0.4106	0.06	13.45
					4-methyl-2-pentanone	0.0000	0.0000	0.00	
n-Heptane	0.0000	0.0000	0.00		2-methyl-3-pentanone	0.0000	0.0000	0.00	
Methylcyclohexane	0.0000	0.0000	0.00		hexanal	2.4875	2.8549	0.37	13.75
2,4-Dimethylhexane	0.0000	0.0000	0.00		benzaldehyde	0.7770	0.9134	0.14	16.14
2,3,4-Trimethylpenta	0.0000	0.0000	0.00		C4 ketone	0.0000	1.8030	1.80	
Toluene	0.6061	0.8388	0.23	32.20	C6 ketone	0.0000	0.0000	0.00	
2,3-Dimethylhexane	0.0000	0.0000	0.00		tolualdehyde ?	5.9897	5.4817	0.51	8.86
2-Methylheptane	0.0000	0.0000	0.00						
3-Ethylhexane	0.0000	0.0000	0.00		Other C2	1.3744	2.4273	1.05	55.39
					Other C3	1.4903	0.8622	0.63	53.40
n-Octane	0.0000	0.1835	0.18		Other C4	3.4210	3.2601	0.16	4.82
Ethylbenzene	0.1778	0.2611	0.08	37.93	Other C5	3.6225	4.4539	0.83	20.59
m-Xylene	0.2918	0.5253	0.23	57.14	Other C6	0.9483	0.8910	0.06	6.23
p-Xylene	0.0000	0.0000	0.00		Other C7	1.3786	1.8813	0.50	30.84
Styrene	0.0877	0.0000	0.09		Other C8	1.2236	1.4151	0.19	14.51
o-Xylene	0.1999	0.2914	0.09	37.27	Other C9	3.4121	3.0487	0.36	11.25
					Other C10	7.1707	3.6835	3.49	64.25
n-Nonane	0.2391	0.4783	0.24	66.68	Other C11	1.3480	0.9809	0.37	31.52
i-Propylbenzene	0.0000	0.0000	0.00						
n-Propylbenzene	0.1473	0.1765	0.03	18.08					
3-Ethyltoluene	0.2418	0.4017	0.16	49.68					
AVERAGE (non-zero values)								0.26	31.35

Table 31 - Aldehyde Composition

Component	formaldehyde as % of aldehydes	formaldehyde as % of ald+ketones
ET-1	7.93	5.47
ET-2	60.53	43.32
ET-3	62.48	30.65
ET-4	14.66	7.28
ET-5	92.00	86.61
ET-6	47.13	33.28
ET-8	60.47	30.09
ET-9	42.30	30.56
ET-10	76.52	52.89
ET-11	76.84	51.87
ET-12	77.16	50.97
ET-13	65.96	35.16
ET-15	33.17	28.26
ET-17	54.98	38.66
ET-18	54.87	36.64
ET-20	55.20	39.09
ET-21	48.99	29.81
ET-23	58.67	40.51
ET-25	38.10	25.61
ET-26	39.71	23.94
ET-27	51.26	34.86
Average %	53.28	35.98

Table 32 - Formaldehyde Content of Category 2 and 3 Sources

Category 2	formaldehyde (% of total HC)	Category 3	formaldehyde (% of total HC)
ET-01	0.0101	ET-17	13.8609
ET-02	0.5560	ET-18	15.0517
ET-03	0.1564	ET-20	19.0662
ET-04	0.0101	ET-21	6.7659
ET-05	3.1622	ET-23	21.7915
ET-06	0.5840	ET-25	16.1934
ET-08	0.5983	ET-26	11.8394
ET-09	0.1093	ET-27	13.0769
ET-10	0.8210		
ET-11	0.6614		
ET-12	2.4286		
ET-13	0.7189		
ET-15	1.5810		
average	0.8767	average	14.7057
std. dev.	0.9608	std. dev.	4.5698

Table 33 - Category 2 Sources

Compound	Average %	sigma	Compound	Average %	sigma
Methane	5.3620	4.0293	1,3,5-Trimethylbenzene	0.8773	0.3189
Ethylene	5.8048	3.9001	2-Ethyltoluene	0.7332	0.3680
Ethane	0.6877	0.4968	t-butylbenzene	0.0000	0.0000
Acetylene	6.3632	4.6786	1,2,4-Trimethylbenzene	2.8280	1.2442
Propene	2.8071	1.7694	i-butylbenzene	0.0257	0.0311
			s-butylbenzene	0.0390	0.0535
Propane	0.6408	0.9276	n-Decane	0.2763	0.3352
Methylacetylene	0.6597	0.5849	1,2,3-Trimethylbenzene	0.3696	0.3224
i-Butane	0.2677	0.1651	indane	0.2434	0.2740
methanol	0.1350	0.1362	1,3-Diethylbenzene	0.0163	0.0589
i-butylene	0.9455	0.5395	1,4-Diethylbenzene	0.2154	0.2711
1-butene	0.6899	0.3486	n-butylbenzene	0.3461	0.5157
1,3-Butadiene	0.9285	0.7870	1,2-Diethylbenzene	0.0904	0.2392
			1,4-dimethyl-2-ethylbenzene	0.2298	0.2520
n-Butane	0.7352	0.3851	1,3-dimethyl-4-ethylbenzene	0.1646	0.2076
trans-2-butene	0.1937	0.1285	1,2-dimethyl-4-ethylbenzene	0.2564	0.3314
2,2-dimethylpropane	0.0000	0.0000	1,3-dimethyl-2-ethylbenzene	0.0944	0.1404
cis-2-butene	0.1473	0.1182			
ethanol	0.0262	0.0283	n-undecane	0.1598	0.3549
i-Pentane	2.9753	1.6642	1,2,3,5-tetramethylbenzene	0.0690	0.1663
1-pentene	0.2331	0.1148	1,2,4,5-tetramethylbenzene	0.1164	0.2782
n-Pentane	1.1909	0.5909	OTHER COMPOUNDS		
trans-2-pentene	0.3317	0.2780	2-propenylbenzene	0.0000	0.0000
cis-2-pentene	0.3111	0.3553	1,2-dichlorobenzene	0.0000	0.0000
2,2-Dimethylbutane	0.3879	0.5676	2-methylstyrene	0.1239	0.3084
Cyclopentane	0.2934	0.3323	1-ethynyl-4-methylbenzene	0.0816	0.2917
2,3-Dimethylbutane	0.2150	0.2232	naphthalene	0.0613	0.2211
2-Methylpentane	1.7380	1.0186			
3-Methylpentane	1.0969	0.6618	OXYGENATES		
			formaldehyde	0.8767	0.9608
n-Hexane	1.1759	0.5047	acetaldehyde	0.2319	0.2569
Methylcyclopentane	1.3691	0.7530	acetone	0.2841	0.2612
2,4-Dimethylpentane	0.3583	0.2194	propanal	0.1156	0.3050
Benzene	4.6581	1.4404	MEK	0.0498	0.0514
Cyclohexane	0.0426	0.0695	butanal	0.0055	0.0075
2-Methylhexane	0.9158	0.6312	2&3-pentanone	0.0004	0.0012
2,3-Dimethylpentane	0.4116	0.2708	cyclohexanone	0.0145	0.0366
3-Methylhexane	0.9530	0.5926	pentanal	0.0016	0.0041
2,2,4-trimethylpentane	0.7198	0.6383	4-methyl-2-pentanone	0.0687	0.0893
			2-methyl-3-pentanone	0.0408	0.0558
n-Heptane	0.5642	0.4477	hexanal	0.0989	0.1585
Methylcyclohexane	0.3658	0.1645	benzaldehyde	0.0705	0.1324
2,4-Dimethylhexane	0.3372	0.2275	C4 ketone	0.0233	0.0315
2,3,4-Trimethylpentane	0.5155	0.4373	C6 ketone	0.0470	0.0762
Toluene	8.2185	2.9394	tolualdehyde ?	0.0000	0.0000
2,3-Dimethylhexane	0.1557	0.1461			
2-Methylheptane	0.3731	0.3504	Other C2	3.5233	5.0966
3-Ethylhexane	0.4263	0.3729	Other C3	0.8401	1.4332
			Other C4	1.1690	0.5502
n-Octane	0.3904	0.2191	Other C5	2.3134	0.7067
Ethylbenzene	1.8015	0.6779	Other C6	3.2076	2.2075
m-Xylene	3.8057	3.0954	Other C7	2.3108	1.9503
p-Xylene	2.0264	1.9999	Other C8	1.8690	0.9243
Styrene	0.1745	0.2965	Other C9	2.5245	1.4506
o-Xylene	2.5522	1.1587	Other C10	2.2177	2.0990
			Other C11	0.5326	0.9150
n-Nonane	0.4298	0.3112			
i-Propylbenzene	0.0834	0.1031			
n-Propylbenzene	0.4286	0.2390			
3-Ethyltoluene	1.7022	1.0071			

Table 33 - Category 3 Sources

Compound	Average %	sigma
Methane	4.0817	4.6205
Ethylene	14.3684	3.6717
Ethane	0.5643	0.6896
Acetylene	4.2526	3.5447
Propene	2.5952	2.2309
Propane	0.1856	0.1741
Methylacetylene	0.4658	0.6573
i-Butane	1.2216	0.9136
methanol	0.0296	0.0442
i-butylene	0.9211	0.5492
1-butene	0.6653	0.5266
1,3-Butadiene	0.1898	0.5027
n-Butane	0.1039	0.1073
trans-2-butene	0.1951	0.1420
2,2-dimethylpropane	0.0000	0.0000
cis-2-butene	0.0944	0.0956
ethanol	0.0081	0.0228
i-Pentane	0.6012	0.4694
1-pentene	0.3236	0.2239
n-Pentane	0.1752	0.1746
trans-2-pentene	0.0398	0.0585
cis-2-pentene	0.0300	0.0373
2,2-Dimethylbutane	0.0607	0.1144
Cyclopentane	0.0121	0.0242
2,3-Dimethylbutane	0.0285	0.0517
2-Methylpentane	0.3919	0.4334
3-Methylpentane	0.1146	0.1396
n-Hexane	0.1564	0.2241
Methylcyclopentane	0.1488	0.1876
2,4-Dimethylpentane	0.0185	0.0319
Benzene	1.9998	1.7540
Cyclohexane	0.0261	0.0372
2-Methylhexane	0.1153	0.1025
2,3-Dimethylpentane	0.0726	0.1037
3-Methylhexane	0.3478	0.1600
2,2,4-trimethylpentane	0.2976	0.1377
n-Heptane	0.0676	0.0676
Methylcyclohexane	0.0682	0.0588
2,4-Dimethylhexane	0.0360	0.0328
2,3,4-Trimethylpentane	0.0148	0.0304
Toluene	1.4713	1.7242
2,3-Dimethylhexane	0.0112	0.0166
2-Methylheptane	0.0571	0.0596
3-Ethylhexane	0.0599	0.0598
n-Octane	0.1392	0.0990
Ethylbenzene	0.3047	0.2261
m-Xylene	0.6110	0.4891
p-Xylene	0.0949	0.1424
Styrene	0.0584	0.0698
o-Xylene	0.3343	0.1964
n-Nonane	0.2303	0.1507
i-Propylbenzene	0.0145	0.0207
n-Propylbenzene	0.1226	0.0663
3-Ethyltoluene	0.2470	0.1811

Compound	Average %	sigma
1,3,5-Trimethylbenzene	0.1937	0.0894
2-Ethyltoluene	0.1380	0.1402
t-butylbenzene	0.0066	0.0186
1,2,4-Trimethylbenzene	0.5293	0.4444
i-butylbenzene	0.1265	0.2412
s-butylbenzene	0.0508	0.0618
n-Decane	0.5279	0.4230
1,2,3-Trimethylbenzene	0.1198	0.1635
indane	0.1874	0.3081
1,3-Diethylbenzene	0.0545	0.0880
1,4-Diethylbenzene	0.1352	0.1629
n-butylbenzene	0.1267	0.1428
1,2-Diethylbenzene	0.0860	0.1356
1,4-dimethyl-2-ethylbenzene	0.1292	0.1900
1,3-dimethyl-4-ethylbenzene	0.0985	0.1093
1,2-dimethyl-4-ethylbenzene	0.1095	0.1498
1,3-dimethyl-2-ethylbenzene	0.1593	0.1468
n-undecane	0.2609	0.6168
1,2,3,5-tetramethylbenzene	0.0358	0.1012
1,2,4,5-tetramethylbenzene	0.0438	0.1238
OTHER COMPOUNDS		
2-propenylbenzene	0.0000	0.0000
1,2-dichlorobenzene	0.0000	0.0000
2-methylstyrene	0.0475	0.1344
1-ethynyl-4-methylbenzene	0.0000	0.0000
naphthalene	0.0853	0.2412
OXYGENATES		
formaldehyde	14.7057	4.5698
acetaldehyde	7.3484	2.5571
acetone	7.5022	2.9769
propanal	0.9687	0.6366
MEK	1.4772	0.5746
butanal	1.8665	2.6525
2&3-pentanone	0.0000	0.0000
cyclohexanone	0.1070	0.2010
pentanal	0.1101	0.2044
4-methyl-2-pentanone	0.0000	0.0000
2-methyl-3-pentanone	0.0000	0.0000
hexanal	3.7967	1.4867
benzaldehyde	0.6989	0.6224
C4 ketone	1.7482	1.8642
C6 ketone	0.8993	2.5437
tolualdehyde ?	2.8189	2.6023
Other C2	0.7809	0.8165
Other C3	0.4641	0.5909
Other C4	1.8495	1.2969
Other C5	1.9882	1.4513
Other C6	0.8922	0.3770
Other C7	1.3572	0.5620
Other C8	1.2137	0.7062
Other C9	2.1501	1.2570
Other C10	2.5929	2.3690
Other C11	0.5649	0.5778

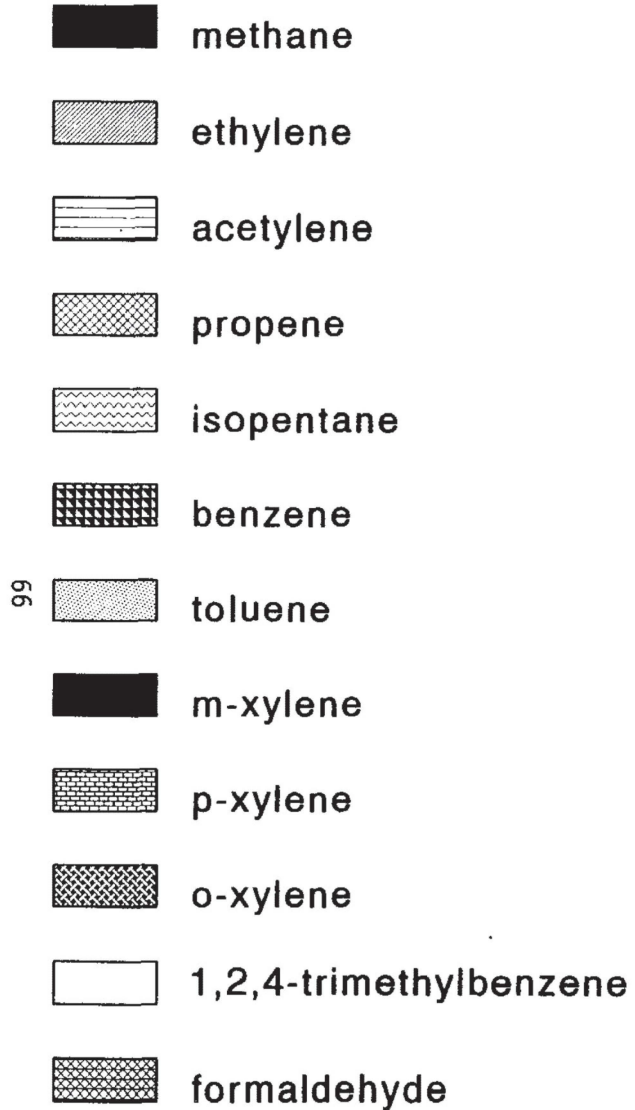

Category 2 Hydrocarbon Profiles
12 Major Components

Figure 20 - Category 2 Major Exhaust Components

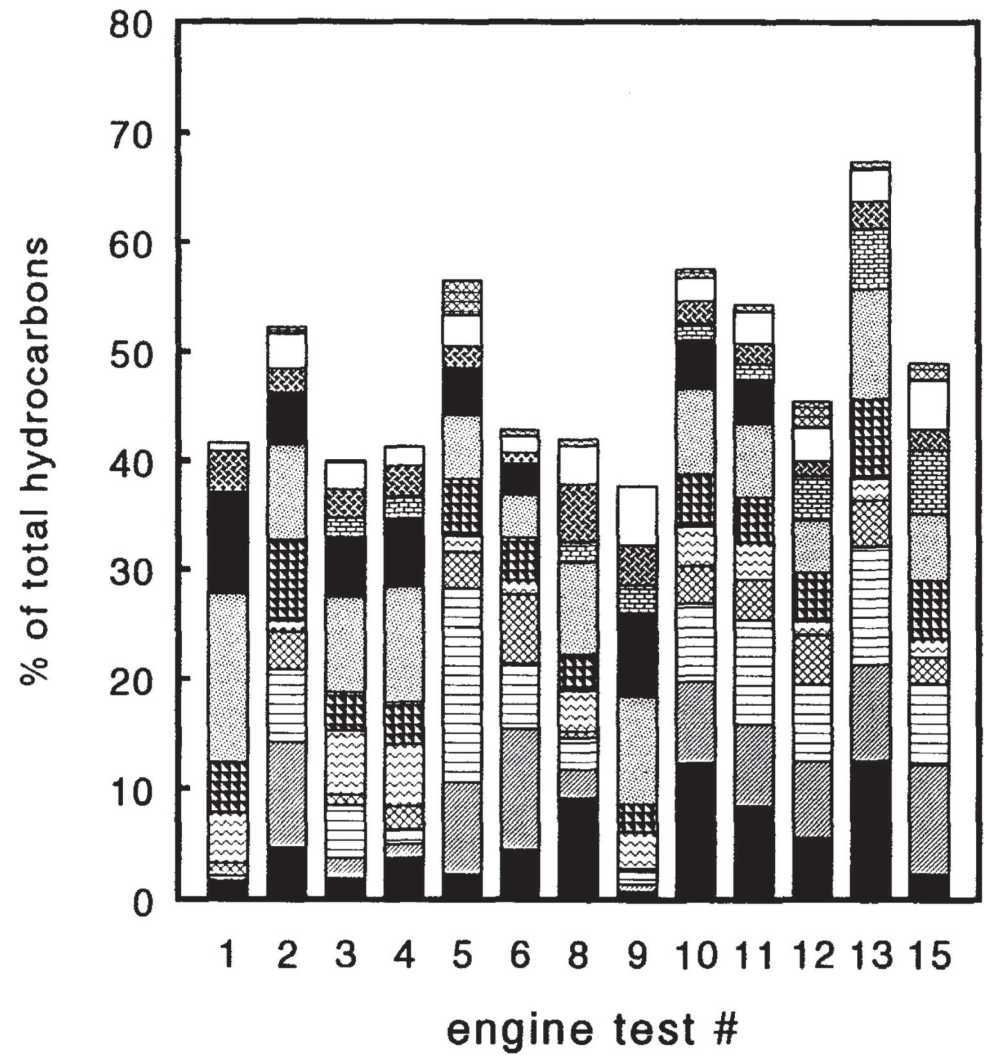

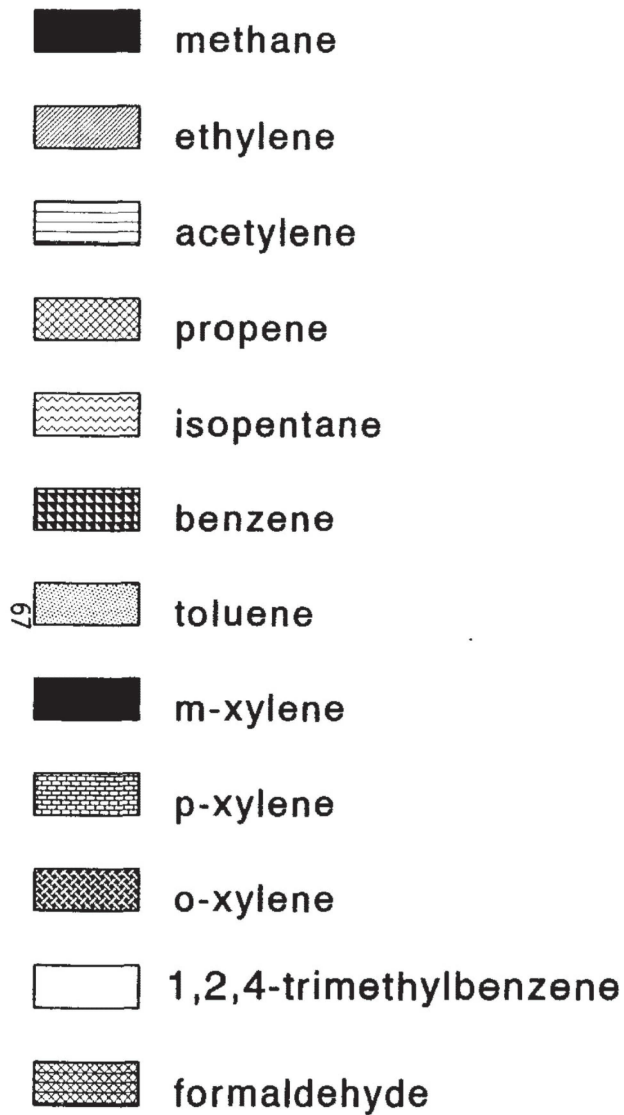

Category 3 Hydrocarbon Profiles 12 Major Components

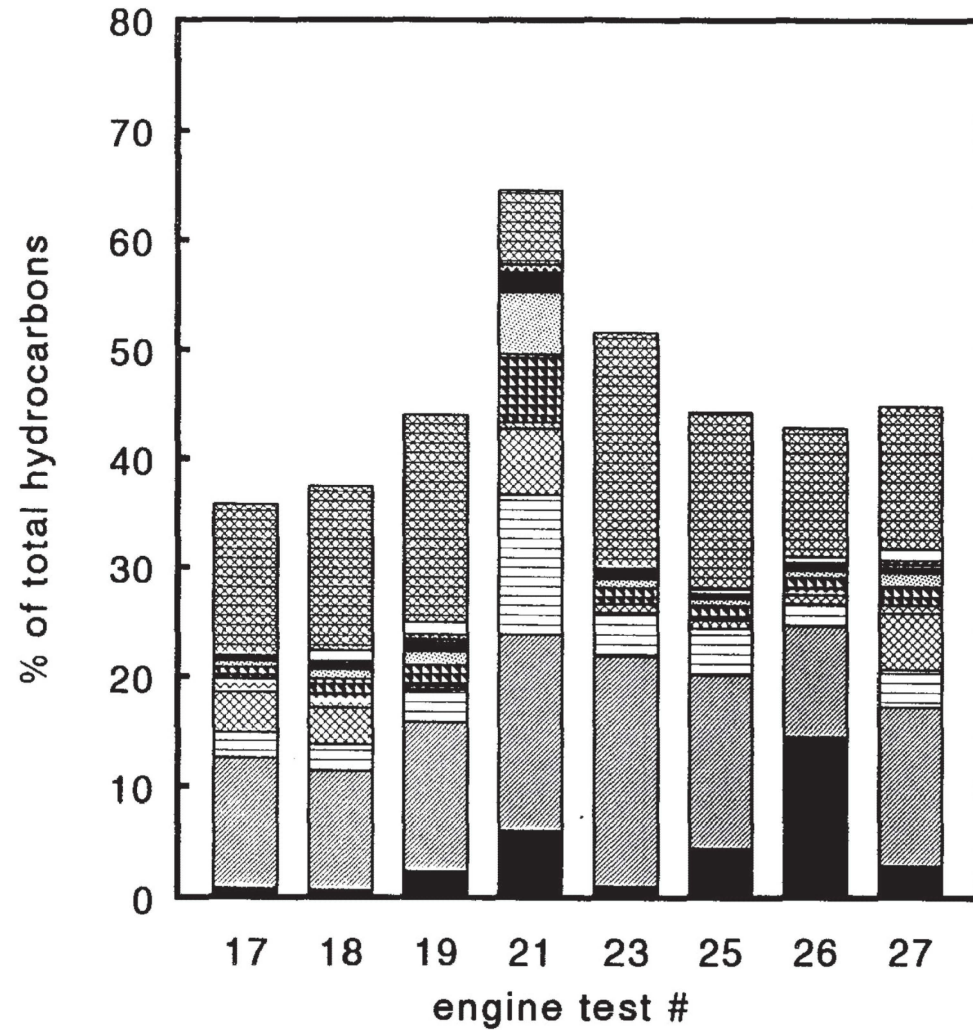

Figure 21 - Category 3 Major Exhaust Components

III. References Cited

- 1 Status Report : Emissions Inventory on Non-Farm, Farm and Lawn and Garden Equipment, California Air Resources Board, Mobile Source Control Division, July 1893
2. Implement and Tractor, pp. 6-15, October 1988
3. Baugh, James, William Ray, Frank Black, *Atmos. Environ.*, **21(10)**, 2077-2082 (1987)
4. MacDonald, J. Scott, Steven L. Plee, SAE Technical Paper 800185, Society of Automotive Engineers (1980)
5. Lipari, Frank, Steven J. Swarn, *Environ. Sci. Technol.*, **19(1)**, 2077-2082 (1987)
6. Tejada, Silvestre B., *Intern. J. Environ. Anal. Chem.*, **26**, 167-185 (1986)
7. Warner-Selph, Mary Ann, *Measurements of Toxic Emissions from Gasoline-Powered Light-Duty Vehicles*, Report to California Air Resources Board, November 1989.
8. Fung, Kochy, AATMA, Inc., Personal Communication.
9. Compendium of Methods for the Determination of Toxic Organic Compounds in Ambient Air, U.S. Environmental Protection Agency, Environmental Monitoring Systems Laboratory, Research Triangle Park, NC 27711
10. Procedures for the Sampling and Analysis of Atmospheric Toxic Compounds, California Air Resources Board, Haagen-Smit Laboratory Division
11. Stigsby, Tejada, et al. , *Environ. Sci. Technol.*, **21(5)**, 466 (1987)
12. Nelson, *Atm. Env.* **18**, 79 (1884)

LITERATURE - Hydrocarbons in Exhaust

Title	Author	Source	Year
1 Feasibility of carbon dioxide monit	Daniel, J. Harrison	Bur. Mines Rep. Invest., RI 9160, 85 pp.	1988
2 Progress in measurement of vehicle	Geib, Ronald C.	JAPCA, 38(3), 280-2	1988
3 Direct capillary gas chromatography	Cuthbertson, R. D.; Shore	J. Chromatogr. Sci., 26(3), 106-12	1988
4 The on-the-road measurement of emis	Potter, C. J.	Pollut. Atmos., No. Spec., 57-69	1987
5 Analysis of exhaust from research I	Hensel, Donald A.	Proc. - APCA Annu. Meet., 80th(Vol. 5), 87/84A.9, 15 pp.	1987
6 Gas chromatograph-based system for	Hoffman, J. S.; Geyer, S.	Report, EPA/600/D-87/097; Order No. PB87-174850/GAR, 31 pp. Avail	1987
7 Source-receptor analysis of volatili	Scheff, Peter A.; Klevs, J.	Environ. Eng. (N. Y.), 113(5), 994-1005	1987
8 Chemical analysis by controlled sam	Phillips, John B.; Gordon, Robert J.; Meredith, David E.		1987
9 Multivariate statistical analyses o	Wolff, George T.; Siak, J.	Atmos. Environ., 20(11), 2231-41	1986
10 Source discrimination of short-term	Wadden, Richard A.; Uno, Environ.	Sci. Technol., 20(5), 473-83	1986
11 Stationary source sampling report: Report,	CORR-85-00484; Order No. DE87003115, 37 pp. Avail.	NTIS From: Energy Res. Abstr.	1985
12 Characterization of exhaust emissio	Smith, L. R.	Report, SWRI-7670, CRC-APRAC-CAPE-30-81-05; Order No. PB85-238582	1985
13 A preliminary assessment of various	Ragazzi, Ronald; Stokes, Proc. - APCA Annu. Meet., 78th(Vol. 4), 85-40.2, 20 pp.		1985
14 Gas chromatographic method for quan	Stump, Fred D.; Dropkin, Anal. Chem., 57(13), 2629-34		1985
15 Mathematical modeling of catalytic	Oh, S. H.; Cavendish, J.	AIChE J., 31(6), 943-9	1985
16 Variability of heavy-duty diesel en	Barsic, N. J.	Soc. Automot. Eng., [Spec. Publ.] SP, SP-578(Diesel Exhaust Emiss	1984
17 National Dioxin Study Tier 4 - comb	U. S. Environ. Prot. Agency, Off. Air Qual. Plann. Stand., [Tech. Rep.] EPA, EPA-450/4-84-		1984
18 Studies in atmospheric chemistry: Mc	Kinney, Peter Michael 69 pp. Avail. Univ. Microfilms Int., Order No. DA8427044 From: D 1		1984
19 Postfire sampling of solid rocket m	Girata, P. T., Jr.; McGreProg. Astronaut. Aeronaut., 91(Spacecr. Contam.: Sources Prev.), 1		1984
20 Monitoring gas composition	Dyer, John Maxwell		1984
21 On-line monitoring methodology for Anon.		Am. Ind. Hyg. Assoc. J., 45(7), 468-73	1984
22 A comparison of photolization det	Clark, A. I.; McIntyre, AInt. J. Environ. Anal. Chem., 17(3-4), 315-26		1984
23 Partial pressure of oxygen sensor-I	Novak, Robert F.		1984
24 Analysis of hydrocarbon emissions f	Shyy, Wei; Adamson, T. C.	Combust. Sci. Technol., 33(5-6), 245-60	1983
25 Is the direct mutagenic activity of	Risby, Terence H.; Lestz, Environ. Sci. Technol., 17(10), 621-4		1983
26 Single-pulse sampling valve measure	Adamczyk, A. A.; Kaiser, Combust. Flame, 52(1), 1-9		1983
27 Exhaust analysis from gasification-	Payne, F. A.; Ross, I. J.	Trans. ASAE, 26(1), 246-9	1983
28 Emission characterization of a spar	Uilman, Terry L.; Hare, C	Report, EPA-460/3-82-003; Order No. PB83-156372, 128 pp. Avail.	1982
29 Analysis of hydrocarbon emissions f	Shyy, Wei	227 pp. Avail. Univ. Microfilms Int., Order No. DA8225045 From: 1	1982
30 Evaluation of a Tenax GC sampling p	Clark, A. I.; McIntyre, AJ. Chromatogr., 252, 147-57		1982
31 Analyses of mixed hydrocarbon binar	Demuth, O. J.; Kochan, R.	Proc. Intersoc. Energy Convers. Eng. Conf., 17th(Vol. 2), 1104-9	1982
32 In-cylinder sampling of hydrocarbon	Ingham, Michael C.; Myers	Report, ARO-15403.3-E; Order No. AD-A112473, 8 pp. Avail. NTIS F 1	1982
33 Hydrocarbon gases emitted from vehi	Hampton, Christine V.; Pi	Environ. Sci. Technol., 16(5), 287-98	1982
34 High-performance semipreparative li	Levine, S. P.; Skewes, L.J.	Chromatogr., 235(2), 532-5	1982
35 IR filtering methods and means for	Bezukh, B. A.; Dunaev, V.	Metrol. Assur. Meas. Environ. Control, Proc., Symp. IMEKO Tech. C 1	1981
36 Measurement of unregulated emissio	Perez, Joseph M.	Environ. Int., 5(4-6), 217-28	1981
37 An industrial hygiene characterizat	Wheeler, Robert W.; Hearl	Environ. Int., 5(4-6), 485-8	1981
38 Concentrations and correlations of	Tsani-Bazaca, E.; McIntyr	Environ. Technol. Lett., 2(7), 303-16	1981
39 An integrated exhaust gas analysis	Anderson, R. C.; Summers,	NASA Tech. Memo., NASA-TM-81592, E-786, 15 pp. Avail. NTIS	1981
40 The optical and probe measurement o	Zabielski, M. F.; Dodge, Symp. (Int.) Combust., [Proc.], Volume Date 1980, 18th, 1591-8		1981
41 Trace chemical analysis methodology	Hillan, William J.; Brook	Report, AFWAL-TR-80-4028, MRC-DA-934; Order No. AD-A090762, 256 p	1980
42 Evolution of a hydrocarbon analyser	Colville, R. F.	Environ. Pollut. Manage., 10(5), 140-3	1980

- 43 Exhaust emissions from in-use passenger cars White, John T., III; Jones SAE Tech. Pap. Ser., 800823, 16 pp.
- 44 Pulp drier volatiles. Part 1. Somerville, J. F. T.; Shore Sugar Ind. Abstr., 99(4), 143-68
- 45 Factors influencing vehicle idle emissions Helme, Marcia P.; Pienta, Environ. Sci. Technol., 14(3), 306-13
- 46 Pulp drier volatiles. I. Some conditions Oldfield, J. F. T.; Shore C. R. Assem. Gen. Comm. Int. Tech. Sucr., 16th, 273-324
- 47 Results obtained from round-robin tests Kraft, Dieter A. Spec. Conf.: Qual. Assur. Air Pollut. Meas., [Proc.], 399-405. E 1
- 48 In-cylinder sampling valve measurements LoRusso, J. A.; Kaiser, E Chem. Phys. Processes Combust. Paper No. 5, 5 pp.
- 49 Comparison of thermocouple, gas sampling Roquemore, W. M.; Yaney, CPIA Publ., 308(JAANAF Combust. Meet., 16th, v2; ADA084681), 51
- 50 The use of a thermogravimetric analyzer Cuthbertson, R. D.; Stint SAE Tech. Pap. Ser., 790814, 18 pp.
- 51 Methodology for determining particulate emissions Black, Frank; High, Larry Soc. Automot. Eng. Tech. Pap. Ser., 790422, 14 pp.
- 52 Optical in situ versus probe measurements Few, J. D.; Bryson, R. J. Report, AEDC-TR-78-32; Order No. AD-A067329, 37 pp. Avail. NTIS
- 53 Diesel hydrocarbon measurement - see Danielson, Eugene Report, LDTP-78/04; Order No. PB-301410, 13 pp. Avail. NTIS From
- 54 A fundamental analysis of hydrocarbon emissions Nakagawa, Yasuhiko; Etoh, JSAE Rev., (1), 98-106
- 55 Development of high temperature subsonic burner Raible, C. J.; Seizinger, Report, BETC/R1-78/12, 11 pp. Avail. NTIS From: Energy Res. Abst 1
- 56 Comparisons of turbine engine combustion Bryson, R. J.; Few, J. D. Report, AEDC-TR-78-7; Order No. AD-A061733, 67 pp. Avail. NTIS From
- 57 In situ optical techniques for jet engine Fisher, C. J. Report, AEDC-TR-78-39; Order No. AD-A061673, 64 pp. Avail. NTIS
- 58 Characterization of the hydrocarbon emissions Khatri, N. J.; Johnson, J. Report, CONF-780208-20, 24 pp. Avail. SAE From: Energy Res. Abst
- 59 Catalytic reactor systems and apparatus Neti, Radhakrishna Murty; Sawa, Kenneth Bruno
- 60 Non-extractive electro-optical measurements Herget, William F. Report, FAA-RD-78-10; Order No. AD-A056783, 27 pp. Avail. NTIS From
- 61 Thin-film thermistor bolometer fabrication Ozaki, Yuzo; Ban, Tsuyoshi JEE, J. Electron. Eng., 139, 44-8
- 62 Effect of catalytic emission control Jackson, Marvin W. SAE [Tech. Pap.], 780624, 24 pp.
- 63 Determination of organic pollutants Seifert, B.; Ullrich, D. Stud. Environ. Sci., 1(Atmos. Pollut.), 69-72
- 64 Remote sensing of gaseous pollutants Herget, William F.; Powell, Jt. Conf. Sens. Environ. Pollut., [Conf. Proc.], 4th, Meeting Date 1
- 65 Vehicle exhaust emission instrument Schlingmann, Steve N. U. S. NTIS, PB Rep., PB-274547, 361 pp. Avail. NTIS From: Gov. R 1
- 66 Fluorescence interferences in Raman scattering Setchell, R. E.; Aeschlim Appl. Spectrosc., 31(6), 530-5
- 67 Monitoring of hydrocarbon emissions Dailey, W. V. Energy Technol. Handb., 9/380-9/390. Edited by: Considine, Douglas
- 68 Gas chromatographic technique for carbon monoxide Black, Marilyn S.; Rehg, J. Chromatogr., 142, 809-22
- 69 Characteristic time emissions correlations Mellor, A. M. J. Energy, 1(4), 244-9
- 70 Development of the Volvo Lambda sensor Engh, Grunde T.; Wallman, SAE [Tech. Pap.], 770295, 16 pp.
- 71 A treatise on exhaust emission tests Juneja, Wiplove K.; Horch SAE [Tech. Pap.], 770136, 24 pp.
- 72 Recommended practices for determining engine emissions U. S. NTIS, PB Rep., PB-270218, 63 pp. Avail. NTIS From: Gov. Rep. Announce. Index (U. S.
- 73 Development of emissions measurement systems Lyon, T. F. U. S. NTIS, AD Rep., AD-A045491, 67 pp. Avail. NTIS From: Gov. R 175
- 74 An analysis of the proposed parking garage Roddin, Marc; Dabberdt, W Proc. - Annu. Purdue Air Qual. Conf., 14, 264-88

LITERATURE - ALDEHYDES IN EXHAUST

	Title	Author	Source	Year
1	The collection and direct analysis of low molecular weight aldehydes in exhaust	Kassir, Abdul Ahad F.	Int. J. Environ. Anal. Chem., Volume Date 1987, 32	1988
2	The collection and direct analysis of low molecular weight aldehydes in exhaust	Habboush, Albertine E.; Farroha, Sabri M.; Naoum, M.	Int. J. Environ. Anal. Chem., Volume Date 1987, 32	1988
3	Analytical method for aldehyde emissions from methanol engine exhaust	Kachi, Hironari; Akiyama, Kenichi; Tsuruga, Fumiko	JSAE Rev., 9(2), 97-100	1988
4	Determination of aldehydes in automobile exhaust	Kaji, Hironari	Kagaku Gijutsushi MOL, 26(5), 140-4	1988
5	Apparatus for analyzing the exhaust gases from automobile engine	Aoyama, Heigoro; Kobuchi, Tamotsu; Ooi, Akihiko; Oochi, Hideo; Yasui, Shigeo; Suzuki, Mikihiro	Report, CRC-551, CRC-APRAC-CAPI-1-64-15; Order No.	1988
6	Method for determining the aldehyde content in exhaust	Uchida, Kenichi; Noguchi, Hiroshi; Sato, Norimasa	Chromatographia, 23(11), 829-34	1988
7	Determination of low boiling aldehydes in air and exhaust	Possanzini, M.; Ciccio, P.; Di Palo, V.; Draisci, G.	Environ. Sci. Technol., 21(5), 466-75	1987
8	Volatile organic compound emissions from 46 in-use automobiles	Sigsby, John E., Jr.; Tejada, Silvestre; Ray, Will	Report, CRC-551, CRC-APRAC-CAPI-1-64-15; Order No.	1987
9	Chemical methods for the measurement of unregulated aldehydes in exhaust	Perez, J. M.; Jass, R. E.; Leddy, D. G.	Int. J. Environ. Anal. Chem., 26(2), 167-85	1986
10	Evaluation of silica gel cartridges coated in situ for aldehyde collection	Tejada, Silvestre B.	Environ. Int., 11(2-4), 119-24	1985
11	Enrichment of gaseous compounds from diluted exhaust	Stenberg, Ulf; Westerholm, Roger; Alsberg, Thomas	Int. J. Environ. Anal. Chem., 21(3), 229-37	1985
12	Determination of carbonyl compounds in exhaust gas	De Andrade, Jailson B.; Miguel, Antonio H.	J. Chromatogr., 333(2), 337-47	1985
13	Determination of aldehydes and ketones by derivatization	Olson, Keith L.; Swarin, Stephen J.	Quim. Nova, 8(4), 356-7	1985
14	The use of reverse phase microcolumns in the sampling of aldehydes	De Andrade, Jailson B.; Miguel, Antonio H.	Report, SWRI-7670, CRC-APRAC-CAPE-30-81-05; Order No.	1985
15	Characterization of exhaust emissions from alcohol engine	Smith, L. R.	Tr. Prom-sti., (5), 41-2	1984
16	Determination of aldehydes in exhaust gases from diesel engine	Tsinman, I. D.; Lukashenko, R. D.; Kagramanyan, N. Bezop.	Soc. Automot. Eng., [Spec. Publ.] SP, SP-578(Diesel)	1984
17	Cooperative development of analytical methods for aldehydes in exhaust	Perez, J. M.; Lipari, F.; Seizinger, D. E.	Bunseki Kagaku, 32(1), 33-8	1983
18	Determination of trace low molecular weight aldehydes in exhaust	Saito, Takashi; Takashina, Toru; Yanagisawa, Sabur	J. Liq. Chromatogr., 6(3), 425-44	1983
19	Determination of formaldehyde and other aldehydes in exhaust	Swarin, Stephen J.; Lipari, Frank	Ochr. Ovzdusi, 15(10), 155-8	1983
20	Primary and secondary pollution of the air by exhaust	Jager, Jiri	Report, BUMINES-OFR-108-84; Order No. PB84-196625,	1983
21	Development of sampling and analytical methods for aldehydes in exhaust	Menzies, K. T.; Beltis, K. J.; Wong, C. M.	J. Chromatogr. Sci., 20(2), 67-72	1982
22	A comparison of three different high-performance liquid chromatographic methods for aldehyde determination	Creech, G.; Johnson, R. T.; Stoffer, J. O.	J. Chromatogr., 247(2), 297-306	1982
23	Determination of formaldehyde and other aldehydes in exhaust	Lipari, Frank; Swarin, Stephen J.	Report, CRC-APRAC-CAPE-30-81; Order No. PB82-25581	1982
24	Comparison of aldehyde methods	Menzies, K. T.; Beltis, K. J.; Fasano, R. E.	Report, EPA-460/3-82-003; Order No. PB83-156372, 1	1982
25	Emission characterization of a spark-ignited heavy-duty diesel engine	Ullman, Terry L.; Hare, Charles T.	Seikatsu Eisei, 26(1), 18-28	1982
26	Air pollution from road traffic in Osaka (1965-1966)	Kawaraya, Toshio; Nakadoi, Takashi; Tomita, Kinuko	Anal. Chem., 53(11), 1708-9	1981
27	Determination of total aliphatic aldehydes in exhaust	Nebel, George J.	Analyst (London), 106(1263), 686-94	1981
28	Simple and rapid gas-chromatographic determination of aldehydes in exhaust	Hoshika, Yasuyuki	Environ. Int., 5(4-6), 217-28	1981
29	Measurement of unregulated emissions: some heavy-duty diesel engines	Perez, Joseph M.	Int. J. Environ. Anal. Chem., 9(1), 7-26	1981
30	Determination of carbonyl compounds in automobile exhaust	Johnson, L.; Josefsson, B.; Marstorp, P.	Report, EPA-460/3-81-020; Order No. PB82-101130, 1	1981
31	Unregulated exhaust emissions from non-catalyst diesel engine	Urban, Charles	Chem. Anal. (Warsaw), 25(6), 1097-103	1980
32	Determination of aldehydes in combustion gases of diesel engine	Konopczynski, Andrzej	Chem. Anal. (Warsaw), 25(6), 1097-1103	1980
33	Apparatus for the determination of aldehydes in exhaust	Konopczynski, Andrzej	Report, IS-T-914; Order No. DE81030743, 304 pp.	1980
34	Liquid-liquid chromatography fractionation of organic compounds in exhaust	Colgrove, S. G.	Toyota Gijutsu, 29(4), 500-6	1980
35	Determination of aldehydes in automotive exhaust gas	Inoue, Tokuta; Oishi, Kiyohiko; Tanaka, Toshiaki	Toyota Gijutsu, 29(4), 500-6	1980
36	Determination of aldehydes in automotive exhaust gas	Inoue, Tokuta; Oishi, Kiyohiko; Tanaka, Toshiaki	U. S. Environ. Prot. Agency, Off. Res. Dev., [Rep.]	1980
37	Measurement of unregulated emissions - some heavy-duty diesel engines	Perez, Joseph M.		

38	Use of the MBTH method for determining aldehyde emCarpuc, Tiberiu	Constr. Mas., 31(3), 181-3	1979
39	Analysis of aldehydes in automotive exhaust gas Kachi, Hironari	Jidosha Gijutsu, 33(11), 912-17	1979
40	Determination of aldehydes in exhaust gases from pKonopczyński, Andrzej; Siedlecki, Andrzej	Tech. Motoryzacyjna, 29(3), 5	1979
41	Aldehyde formation by photochemical reactions Shimada, Isamu; Saito, Keizo; Chisaka, Fumitake; Y Kikai Gijutsu Kenkyusho Shoho, 32(2), 62-77		1978
42	The effect of fuel hydrocarbon composition on exhaHosaka, K.; Onodera, T.; Wigg, Eric E.	SAE [Tech. Pap.], 780625, 12 pp.	1978
43	Spectrophotometric determination of aldehydes and Konopczyński, Andrzej	Chem. Anal. (Warsaw), 22(4), 809-13	1977
44	Analysis of phenols and aromatic aldehydes intomobKimura, Kazuo; Kachi, Kosei; Nakano, Nobuhiko; Ito Jidosha Gijutsukai Rombunshu, 13, 35-40		1977
45	Analysis of phenols and aromatic aldehydes in autoKimura, Kazuo; Kachi, Kosei; Nakano, Nobuhiko; Ito Jidosha Gijutsukai Rombunshu, 13, 35-40		1977
46	Exhaust and evaporative emissions from a BrazilianFurey, Robert L.; Jackson, Marvin W.	Proc. - Intersoc. Energy Convers. Eng. Conf., 12,	1977
47	Measuring and testing procedures for motor vehicleKlingenberg, Horst	Tech. Mess. ATM, 44(1), 3-14	1977
48	Study of exhaust emissions from 1972, 1974, and 19Martin, Aaron R.; Specht, Robert D.; Anstey, Leslie U. S. NTIS, PB Rep., PB-274526, 182 pp. Avail. NT		1976
49	Development of a portable polarograph for determinMcLean, James D.; Holland, John F.	Environ. Sci. Technol., 9(2), 127-31	1975
50	Tentative method for determination of benzaldehydeSmith, R. G.	Health Lab. Sci., 12(2), 167-70	1975
51	Tentative method for determination of benzaldehydeSmith, R. G.	Health Lab. Sci., 12(2), 167-70	1975
52	tomobile exhaust gas and photochemical smog Shimada, Isamu	Kuki Seijo, 12(6), 18-31	1975
53	Analysis of automotive exhaust gas Aoyama, Hyogoro	Kuki Seijo, 12(6), 46-67	1975
54	The diesel as an alternativetomobile engine Henein, Naeim A.	SAE [Tech. Pap.], 750931, 15 pp.	1975
55	Portable polarographic analyzer and quick polarogrMcLean, James D.; Holland, John F.	unknown	1975
56	Analysis of automobile emissions.II.Determination Yamaki, Naoomi; Kita, Takaaki; Yoshida, Koichi; Ta Shimadzu Hyoron, 31(3), 77-91		1974
57	Gas detector for oxidizable gas Obayashi, Hidehito; Gejyo, Tetsuo; Kudo, Tetsuichi		1974
58	Development and evaluation of a portable aldehydesMarcote, Roland V.; Chand, Ramesh; Johnston, Timot Anal. Instrum., 11, 31-43		1973
59	Comparative analysis of the composition of exhaustRytvinskii, G. N.; Raikov, I. Ya.	Avto. Prom., 39(4), 8-10	1973
60	Determination of air pollution in a locomotive cabProkhorov, A. A.; Novikova, I. S.; Pervukhina, I. Gig. Sanit., (11), 66-9		1973
61	Analysis of automobile exhaust Yamaki, Naoomi; Kita, Takaaki; Takahashi, Takeo; K Shimadzu Hyoron, 30(1), 41-61		1973
62	Analysis of automobile exhaust Yamaki, Naoomi; Kita, Takaaki; Takahashi, Takeo; K Shimadzu Hyoron, 30(1), 41-61		1973
63	Association oftomative fuel composition with exhauDimitriades, Basil; Eccleston, B. H.; Sturm, G. P. U. S. Nat. Tech. Inform. Serv., PB Rep., No. 22260		1973
64	Characterization of particulates and other nonreguGentel, James E.; Manary, Otto J.; Valenta, Joseph U. S. Nat. Tech. Inform. Serv., PB Rep., No. 22424		1973
65	Reactivities of exhaust aldehydes Dimitriades, Basil; Wesson, T. C.	J. Air Pollut. Contr. Ass., 22(1), 33-8	1972
66	Oxygenates in exhaust from simple hydrocarbon fuelSiezinger, Donald E.; Dimitriades, Basil	J. Air Pollut. Contr. Ass., 22(1), 47-51	1972
67	Health hazard evaluation/toxicity determination. Burton, David J.; Ligo, Robert N.	U. S. Nat. Tech. Inform. Serv., PB Rep., No. 22915	1972
68	Motor vehicle emission control system Oberdorfer, Paul E., Jr.		1972
69	Aromatic aldehydes and phenols in the exhaust fromHinkamp, J. B.; Griffing, M. E.; Zutaut, D. W.	Amer. Chem. Soc., Div. Petrol. Chem., Prepr., 16(2)	1971
70	Improved instrumentation for determination of exhaDay, Alan G., III; Beggs, David P.; Vestal, Marvin U. S. Nat. Tech. Inform. Serv., PB Rep., No. 21025		1971
71	Development of a formaldehyde analyzer for motor vJohnston, Timothy H.; Marcote, Roland V.; Chand, R U. S. Nat. Tech. Inform. Serv., PB Rep., No. 21026		1971
72	Boron trifluoride etherates for treating internal Herbsman, Abraham M.	unknown	1971
73	Krasnova, S. I.; Pavlikova, E. N.	Khim. Tekhnol. (Kiev), (1), 46-8	1971
74	Direct gas chromatographic analysis of low molecuBellar, Thomas A.; Sigsby, John E., Jr.	Environ. Sci. Technol., 4(2), 150-6	1970
75	System and process for determining the amount of alInnes, William B.		1970
76	Oxygenates in automotive exhaust gas.II.DetermininAnon.	Coord. Res. Counc., Inc., Rep., No. 417, 1-26	1969
77	Determination of the aldehyde content in the exhauParimskii, A. I.; Bondarenko, N. A.; Mikhailov, V. Maslo-Zhir. Prom., 35(9), 37-9		1969
78	Method for sampling and determination of organic cFracchia, Mario F.; Schuette, Fred J.; Mueller, Pe Environ. Sci. Technol., 1(11), 915-22		1967

Appendix C - Photographs of Selected Sampling Setups



ET-3

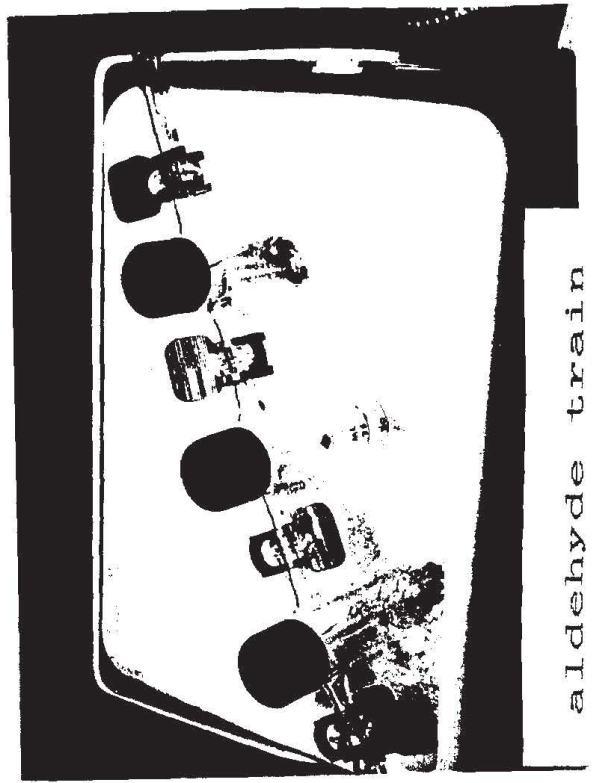

aldehyde train

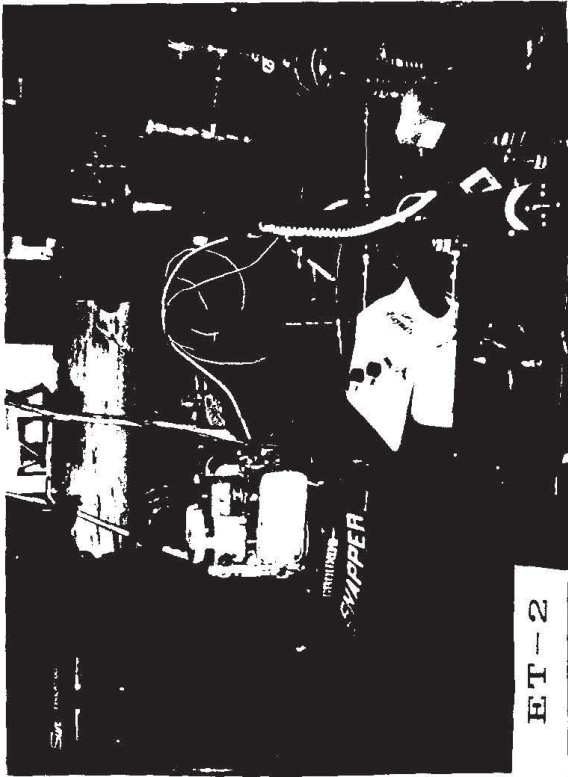

ET-2

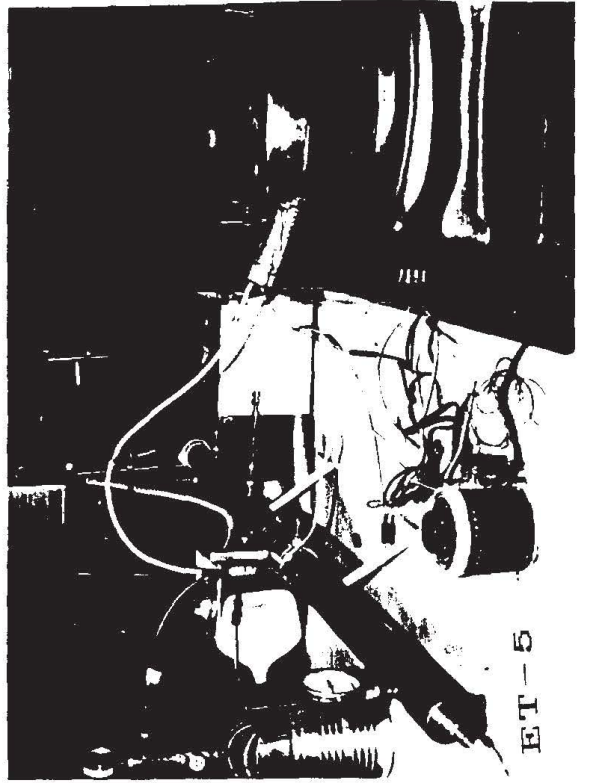

ET-5

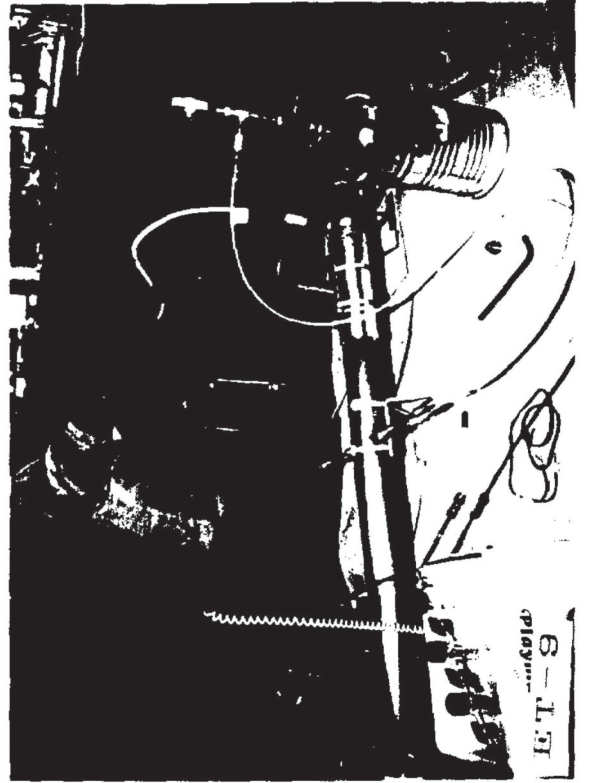
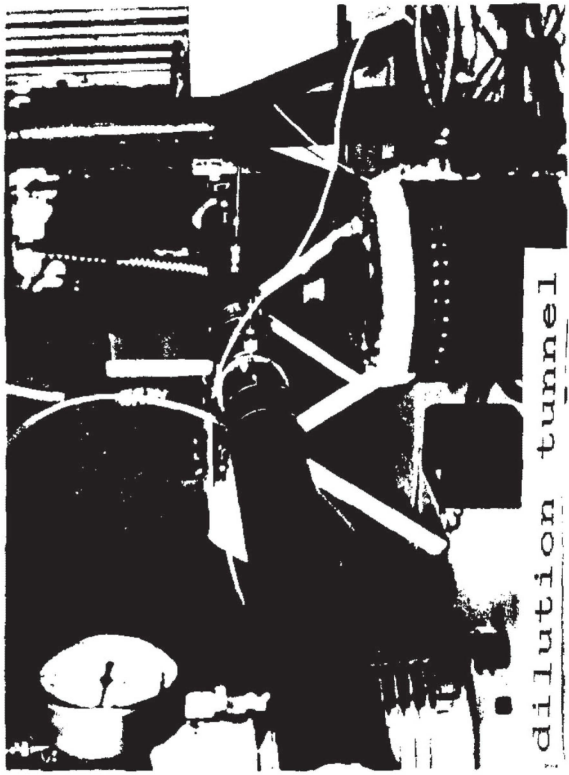
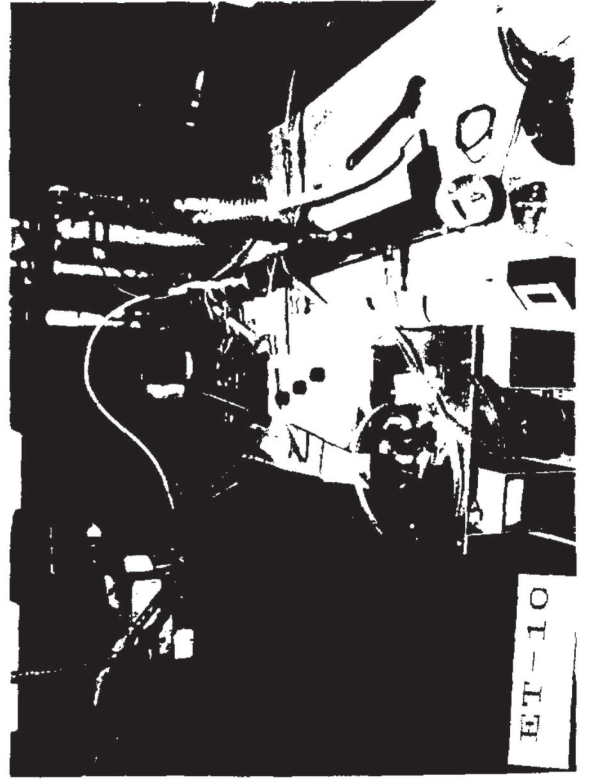

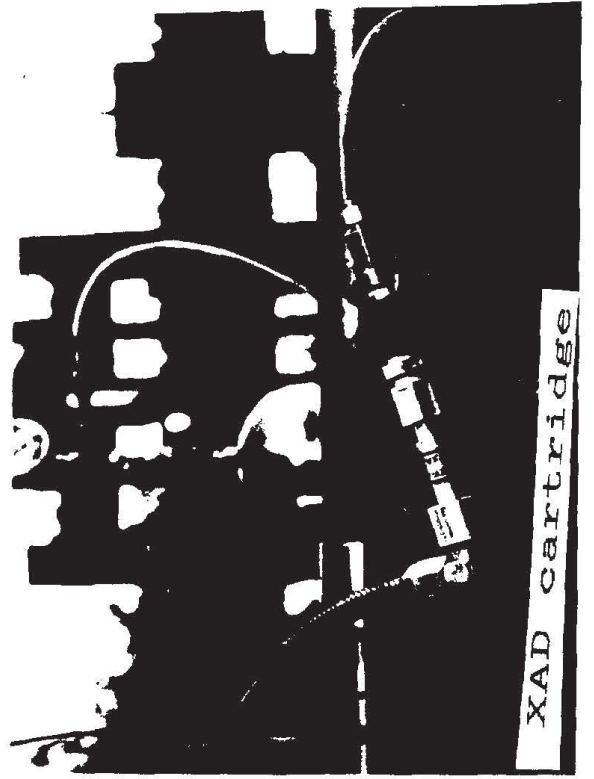
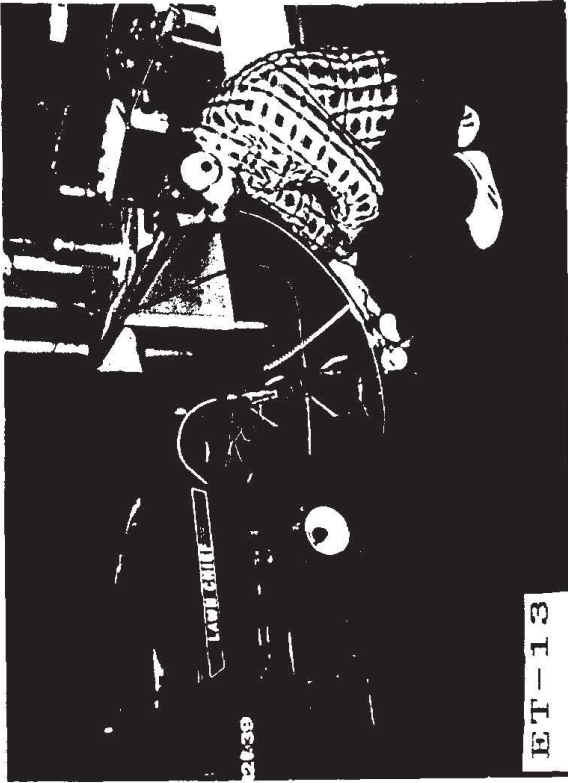
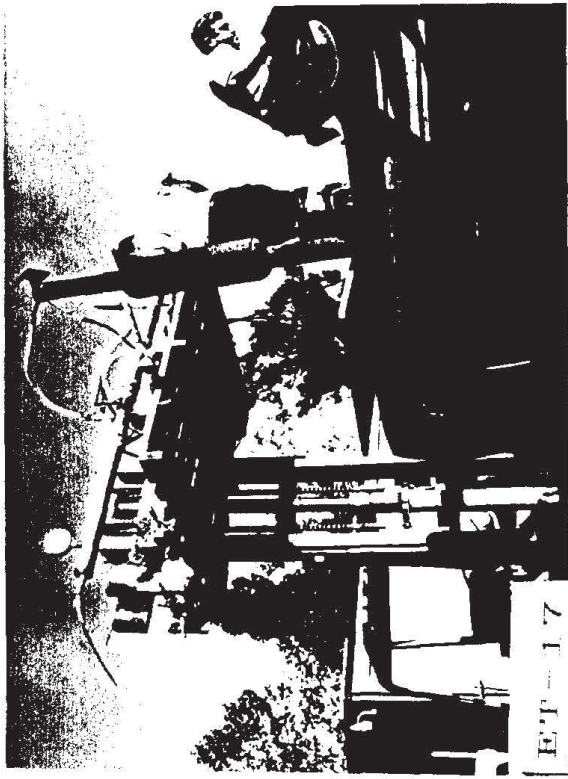

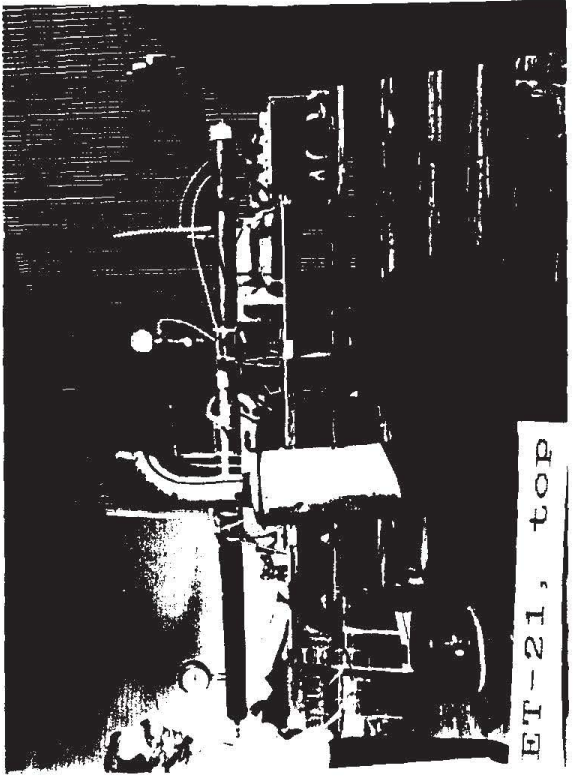
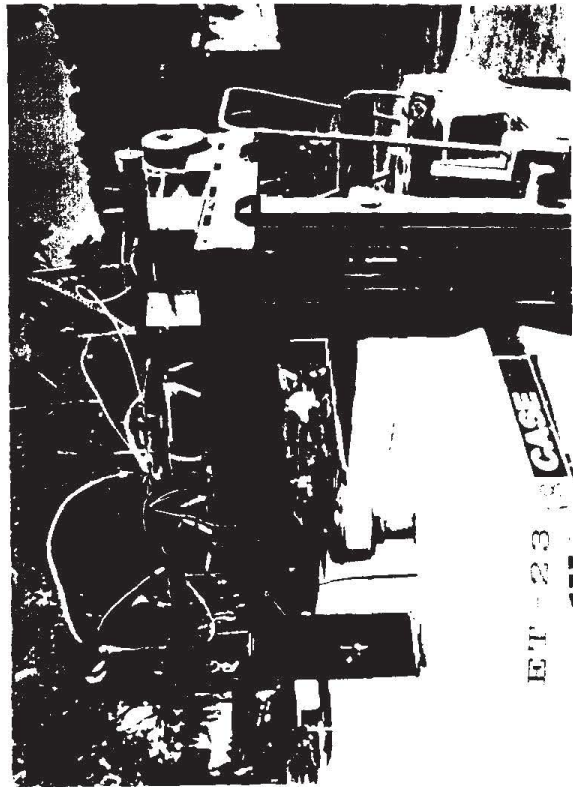
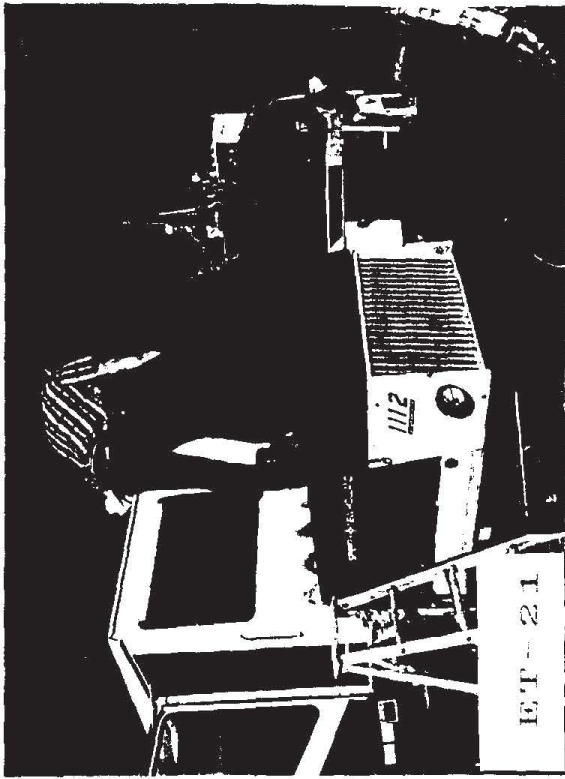

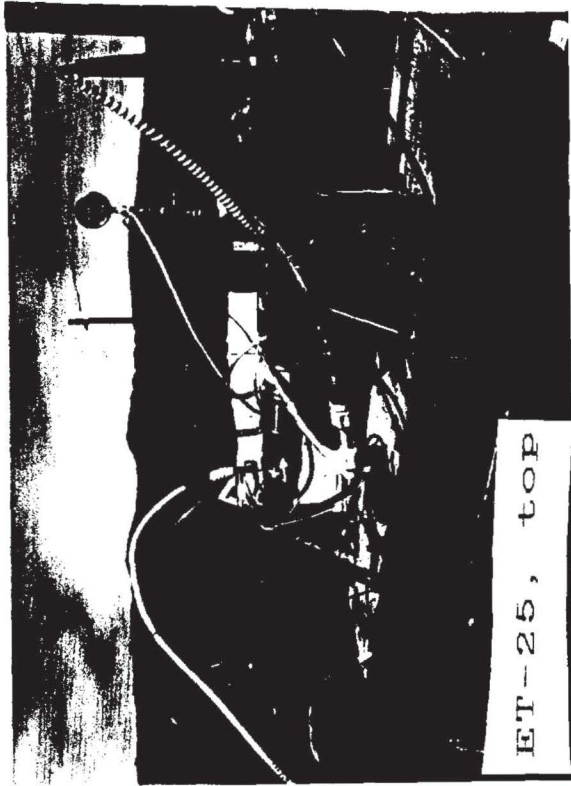

Appendix D - Protocol for Sampling Engine Exhaust Emissions

Appendix D - Protocol for Sampling Engine Exhaust Emissions

1. Applicability

- 1.1 The procedures described herein will be applied to sampling exhaust from selected utility and heavy-duty engines.

2. Method

- 2.1 Engine exhaust CO₂ content will be determined by NDIR analysis.
- 2.2 Engine exhaust will be pulled into a dilution mini-tunnel by the action of low pressure in a sonic nozzle placed in the dilution tunnel.
- 2.3 Engine exhaust will be diluted with zero air in the approximate ratio of 1:10.
- 2.4 Diluted exhaust will be sampled simultaneously at two ports.
 - 2.4.1 Samples for hydrocarbon analysis will be collected in evacuated, passivated stainless steel canisters.
 - 2.4.2 Samples for aldehyde analysis will be pulled through a series of two midjet impingers filled with acidified acetonitrile and DNPH.-
- 2.5 Analysis for hydrocarbons will be performed using gas chromatography with flame ionization or mass spectrometric detection, as appropriate.

3. Components

- 3.1 A cylinder of zero air, containing less than 0.1 PPM hydrocarbons.
 - 3.1.1 A size 3 or size 2 cylinder of Ultra Zero Air, from Matheson, Cucamonga, CA.
 - 3.1.2 A pressure regulator capable of providing cylinder outlet pressures in the range of 0-200 PSIG, MODEL 1H, Matheson, Cucamonga, CA.

- 3.2 Pressure gauge, 0-200 PSIG, #63-3122, from Matheson, Cucamonga, CA.
- 3.3 Magnetic gauge, 1-5 inches of water, Dwyer Instruments, Michigan City, IN, or a slack tube nanometer capable of reading in same range.
- 3.4 SUMMA-passivated stainless steel canister, 3.2 liters.
- 3.5 Dilution mini-tunnel.
- 3.6 DNPH, acetonitrile, hydrochloric acid, Baxter Scientific, Irvine CA.
- 3.7 An air sampling pump, capable of flow rates in the range of 1-2 liters/min.
- 3.8 A rotameter, Ace Glass, Vineland, NJ.
- 3.9 A dry test meter to total aldehyde sampling volume. Alternatively, an electronic soap bubble flowmeter.

4. Procedure

- 4.1 Engine information is recorded on data sheet.
- 4.2 Perform engine compression check, if appropriate.
- 4.3 Inspect spark plug, and replace as appropriate.
- 4.4 Inspect fuel level. Fill with an amount of fuel (pre-mixed, if required) adequate for duration of test.
- 4.5 Assemble hydrocarbon sampling train.
 - 4.5.1 Check pressure in stainless steel canister.
- 4.6 Assemble aldehyde sampling train.

- 4.6.1 Set pump flow rate at desired value (0.4 to 2.0 l/min).
- 4.7 Attach zero air source to dilution tunnel.
- 4.8 Set zero air pressure and flow, in accordance with desired dilution ratio.
- 4.9 Start and warm up test engine.
- 4.10 With engine under load, measure CO₂ level in exhaust with NDIR exhaust gas analyzer.
- 4.11 Insert tunnel probe into engine exhaust stream.
- 4.12 Check CO₂ content of exhaust leaving dilution tunnel, using NDIR analyzer.
- 4.13 When CO₂ content has reached steady state, record time and begin sampling.
 - 4.13.1 With aldehyde sampling pump running, open aldehyde tunnel port.
 - 4.13.2 Collect aldehyde sample for 10-15 minutes.
 - 4.13.3 Concurrent with aldehyde sample collection, open hydrocarbon tunnel port.
 - 4.13.4 Open canister valve, and allow sample to fill canister. Orifice dimensions should be selected to allow 10-15 minutes for filling to be completed.
 - 4.13.5 At end of sampling interval, close aldehyde and hydrocarbon ports.
 - 4.13.6 Record canister final pressure, and close canister valve.
 - 4.13.7 Shut off aldehyde sampling pump, remove sampling cartridge, seal both ends with caps, and place into screw capped culture vial.

Appendix E - ANALYTICAL METHODOLOGY AND CALIBRATION

5.1 Introduction to Analytical Methodology

Environmental Analytical Service, Inc. (EAS) performed the chemical analysis of diluted engine exhaust and bagged component samples using dedicated gas chromatographs (GC) equipped with flame ionization detectors (FID). The FID provides maximum sensitivity for hydrocarbons and has a selective response to hydrocarbon atoms. With proper gas chromatographic separation methods, the concentration of components in complex mixtures can be accurately determined. A GC equipped with a mass spectrometer detector (MSD) was used for confirmation of compound identities in collected samples. These methods provided complete compound speciation for all photochemically reactive organic compounds (PROC) as described in the EPA document Guidance for the Collection and use of Ambient Hydrocarbon Species Data in Development of Ozone Control Strategies (Singh, 1980). The following sections describe the analytical methods EAS used for the fugitive emissions study.

5.1.1 Analysis of Methane

Methane in the collected samples was analyzed using a Carle AGC 100 isothermal gas chromatograph. The methane was separated from air and CO using a 6' Molecular Sieve 5A Column at 50 °C. The helium carrier gas flow rate used was 30 mL/min. Air pressure was maintained at 16 psig and hydrogen pressure at 22 psig, as recommended by the manufacturer. A 2.0 mL sampling loop was used to measure the sample size. The sample loop was kept in a thermostated oven to maintain constant volume. The peaks were integrated using a HP 3393A computing integrator which directly calculated the methane concentration in ppmC. The relative precision for methane at 1,725 ppbvC is 0.2 to 0.4%. The response has been demonstrated to be linear to 20 ppmvC.

5.1.2 Light Hydrocarbon Analysis (C2 to C4) at Low Concentrations

The light hydrocarbons were analyzed using a GC/FID packed column procedure. The column and procedure used for analysis is recommended by EPA and described in California Air Resources Board Method 104. The column used was 1/8" by 10' stainless steel packed with phenyl-isocyanate on Durapack 80/100 mesh. The gas chromatograph used was an HP 5890 with a Model HP3393A computing integrator equipped with chart readout. A 100 to 500 mL gas sample was concentrated using a glass bead freezeout loop procedure. The column was operated isothermally at 28 °C.

A diagram for the instrumental set-up for light hydrocarbon analysis is shown in Figure 5.1.1. The sample canister is connected to a counterflow dryer made of Nafion tubing. The dryer removes water vapor from the sample before analysis. The sample loop is immersed in a Dewar flask filled with liquid oxygen, which traps out hydrocarbons from C2 to C10 quantitatively. The sample is pulled through the glass bead freezeout loop by vacuum. The volume of sample was determined by measuring the pressure drop in a 1.2 liter canister. A precision vacuum test gauge was used to measure the pressure change from which the volume of sample can be calculated (see Section 6.3.3). The system can be used to accurately measure a sample size of 100 to 500 mL.

Once the constituents are trapped, the six port valve is switched from <load> to <analyze>, and the freezeout loop is placed in 80 °C water to thermally desorb the hydrocarbons. The desorbed compounds flow to a 1/8" by 10' stainless steel column packed with phenylisocyanate on Durapack 80/100 mesh. Analysis is performed isothermally at 28 °C. The column flow is controlled by column head pressure and is maintained at 20 psig to give a flow of 40 mL/min. The hydrocarbons are analyzed on a FID detector. The operating conditions are summarized in Table 5.1.

FIGURE 5.1 LIGHT HYDROCARBON ANALYSIS SETUP

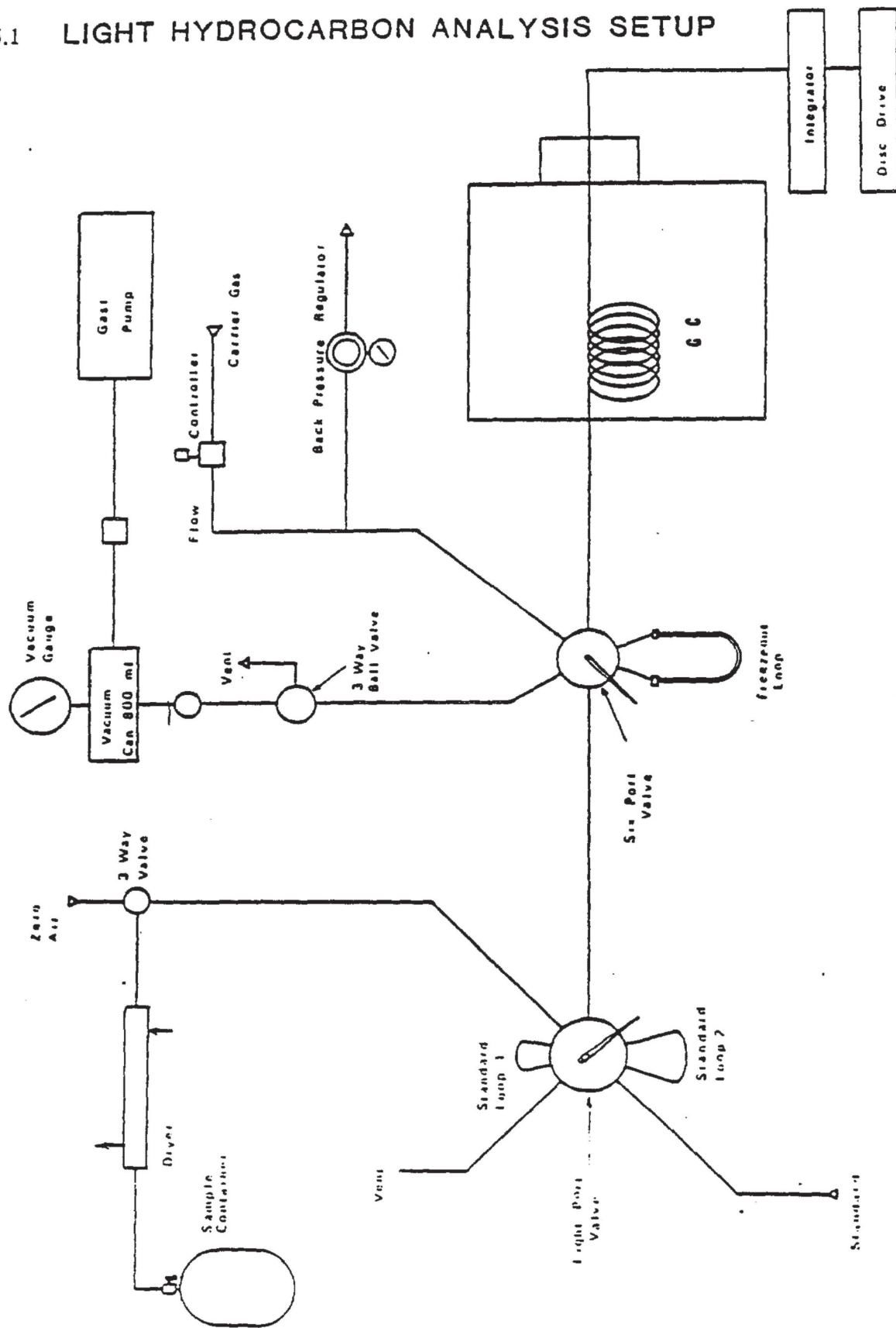

TABLE 5.1

OPERATING CONDITIONS

METHANE -

Flows -
 Helium 30 ml/min
 Hydrogen 30 ml/min
 Gas Pressures -
 Helium (Column Pressure) 40 psig
 Hydrogen (Flame) 24 psig
 Air (Flame) 15 psig
 Temperature Program - 50 C
 Detector Temperature - 150 C
 Sample Size - 1.0 ml

LIGHT HYDROCARBONS -

Flows -
 Helium 29 ml/min
 Hydrogen 31 ml/min
 Air 340 ml/min
 Gas Pressures -
 Helium (Column Pressure) 40 psig
 Hydrogen (Flame) 17.5 psig
 Air (Flame) 34 psig
 Temperature Program - 30 C
 Detector Temperature - 250 C
 Sample Size - 500 ml

HEAVY HYDROCARBONS -

Flows -
 Air 420 ml/min
 Nitrogen 43 ml/min
 Gas Pressures -
 Hydrogen (Column Pressure) 7 psig
 Hydrogen (Flame) 17 psig
 Air (Flame) 35 psig
 Nitrogen (Make-up Gas) 30 psig
 Temperature Program - -20C for 2 min, Program Rate 6 C/min
 Detector Temperature - 275 C
 Sample Size - 500 ml

The peak areas were integrated using an HP 3393A computing integrator with chart recorder. The charts were examined to verify proper system operation and chromatographic resolution. The integrated data were used to calculate the concentration of the constituents. These results were compared with standard runs, and quantified against a commercial propane standard that is traceable to NBS standards (see Section 5.4.2). Response factors of hydrocarbons other than propane are based on carbon number and checked experimentally and against literature values (Dietz, 1967). Hard copies of the chromatograms, and integrated data are EAS proprietary materials which are stored permanently at the laboratory for a five year period. These materials are available for inspection by the client at the EAS laboratory and are not released in copy form to the client.

Analysis of Light Hydrocarbons (C2 to C6) at High Concentrations.

Some light hydrocarbons from bagged component samples were present at high concentrations. These samples were analyzed on the Carle AGC 100 GC using a 1/8" x 30' column containing 23 % SP-1700 on 80/100 Chromosorb PAW operating at 75 °C, isothermal. A 1.0 mL sample loop with backflush was used for direct injection. Concentrations in the 0.1 percent to 100 percent range were measured using a thermal conductivity detector (TCD). The precision for this method at 5 percent concentration is 0.5 percent. For concentrations in the 1 to 1000 ppmvC range, a FID was used. The precision at 9.5 ppmv is 1.0 percent. EAS maintains a complete line of commercial light hydrocarbon standards spanning the range of 10 ppmv to 10 percent. The results were integrated using an HP 3393A integrator and the concentrations of the individual hydrocarbons were determined by transferring the integrated areas into a HP 150 computer using a LOTUS 1-2-3 spreadsheet.

5.1.3 Heavy hydrocarbon and Oxygenates Analysis (C5 to C10)

The heavy hydrocarbons and oxygenates (aldehydes and ketones) were analyzed using an HP 5890 with a fused silica capillary column. This method was described in Sing (1980). This publication describes the use of a canister-based system in conjunction with a freezeout loop for the analysis of sub-par billion hydrocarbons and stable oxygenates. The analysis procedure is similar to that used by Westburg (1984) and Rasmussen (1987). The capillary column provides the required resolution to separately identify the individual reactive organic compounds. Major components that cannot be identified using FID were analyzed for confirmation on an HP 5890/5970 GC/MSD system as described in EPA Method TO-14. A diagram for the instrumental set-up is shown in Figure 5.1.2. The heavy hydrocarbons are analyzed by passing the sample through a Nafion dryer into the 8" glass bead freezeout loop immersed in liquid oxygen. The components are desorbed into a fused silica cryofocussing loop with 80 °C hot water. They are then desorbed from the cryofocus loop and the components are separated using a 100-meter 0.25-micron fused silica capillary column with a 0.5-micron coating. The column is programmed from -20 °C to 200 °C at 3 °C/min. Total analysis time is 60 minutes. The method detection limit for this method is about 0.1 ppbvC for most compounds and the analytical precision at 10 ppbvC is 5 percent. The compounds are detected on a FID set to operate at high sensitivity. A detailed description of the analytical procedure is given in section 5.2.3. Chromatograms were integrated using an HP 3393A computing integrator and stored on a HP 9114 disk drive for reintegration or further examination if required at a later date. Compounds were calibrated using an NBS-traceable propane/hexane/benzene standard. On the FID, hydrocarbons have a uniform response based on the number of carbon atoms. Data from the integrator were entered into a LOTUS 1-2-3 spreadsheet to generate the final report.

HEAVY HYDROCARBON ANALYSIS SETUP

FIGURE 5.2

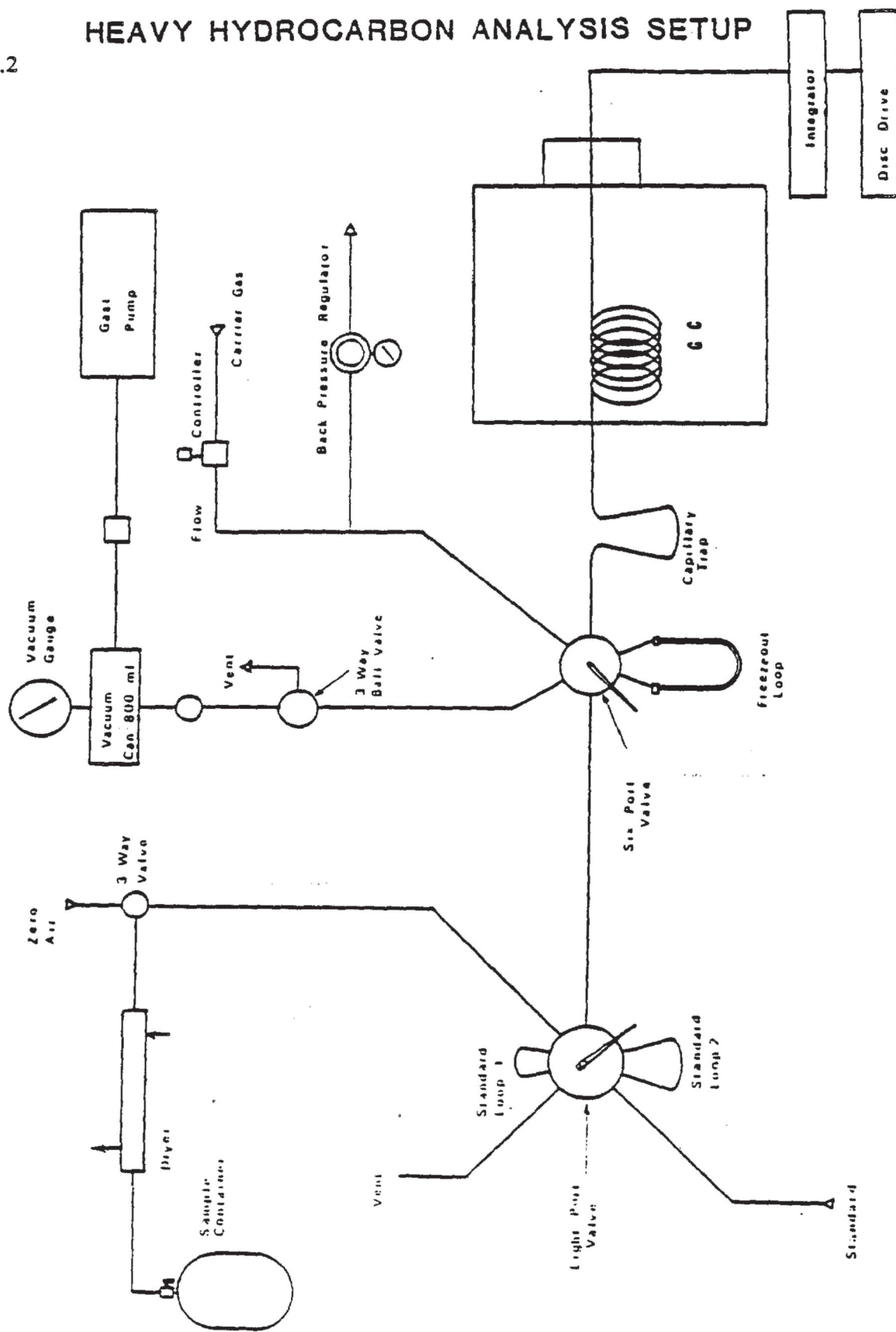

5.1.4 Compound Analysis and Identification

The GC/MS method (EPA Method TO-14) uses a cryotrapping system and a high resolution capillary column to analyze for volatile organic compounds.

A diagram of the analytical system, with an HP 5970 MSD for the detector, is shown in Figure 5.1.3. A 100 to 1000 mL gaseous sample is introduced from the air sampling canister through a Nafion dryer to the freezeout loop. The freezeout loop is immersed in liquid oxygen and concentrates the air sample. After the sample is loaded, it is cryofocused onto the beginning of a 30 meter fused silica capillary column. The cryofocused loop is then warmed and the compounds are separated and enter the mass spectrometer. The GC/MS has a complete data system capable of collecting, storing, and interpreting the data collected. The GC/MS is tuned and operated according to the specifications outlined in EPA SW 846 Test Methods. Compounds were calibrated by the external standard procedure using a NBS traceable Scott-Marrin air standards. The relative standard deviation of the method is 20% at 5 ppbv and the MDL is 0.5 ppbv for most compounds.

5.1.5 Permanent Gases (Nitrogen, Oxygen, Carbon Dioxide, Methane)

The permanent gases were analyzed by a SCAQMD method using a GC with a thermal conductivity detector and a FID on a Molecular Sieve 5A column a Poropak Q/N column mix. the system uses a 1 mL sample loop and is set-up with column backflush and bypassing to simultaneously measure the Carbon Dioxide and other fixed gases. The instrument is run isothermally at 70^o C with helium carrier gas and has a detection limit of 0.05%. For low levels of Carbon Dioxide a catalyst is used to convert the Carbon Dioxide to Methane for analysis.

5.1.6 Aldehydes by the DNPH method

The C1 to C4 aldehydes were analyzed by a modification of EPA Method TO5. This method is based on the reaction of low molecular weight aldehydes and ketones with 2,4-dinitrophenylhydrazine to form stable derivatives. The source gases were sampled using midget impingers filled with acidified DNPH in acetonitrile. An aliquot of the impinger contents was analyzed using high performance liquid chromatography. The analytical column used was a Supelcosil LC18 reverse phase type, with a Supelco guard column. The system was run isocratically, using 70% methanol / 30% water as the eluant. The sample, typically 15 microliters, was injected with a Pressure-Lok syringe. The aldehydes were detected using a UV-visible detector operating at a wavelength of 360 nm, and quantified using an HP 3393A computing integrator.

5.2 Analytical Standard Operating Procedures

5.2.1 Methane Analysis

1. Standards

This procedure is used to load standards at high concentrations (5 ppmv) and have them diluted using calibrated loops to give GC responses equivalent to ambient concentrations. Dilution is 1/1000 with an uncertainty of less than 5%.

- a. Set system to operating parameters given in Table 5.1.b.
- b. Light FID, and place sample valve in load position.

FIGURE 5.1.3

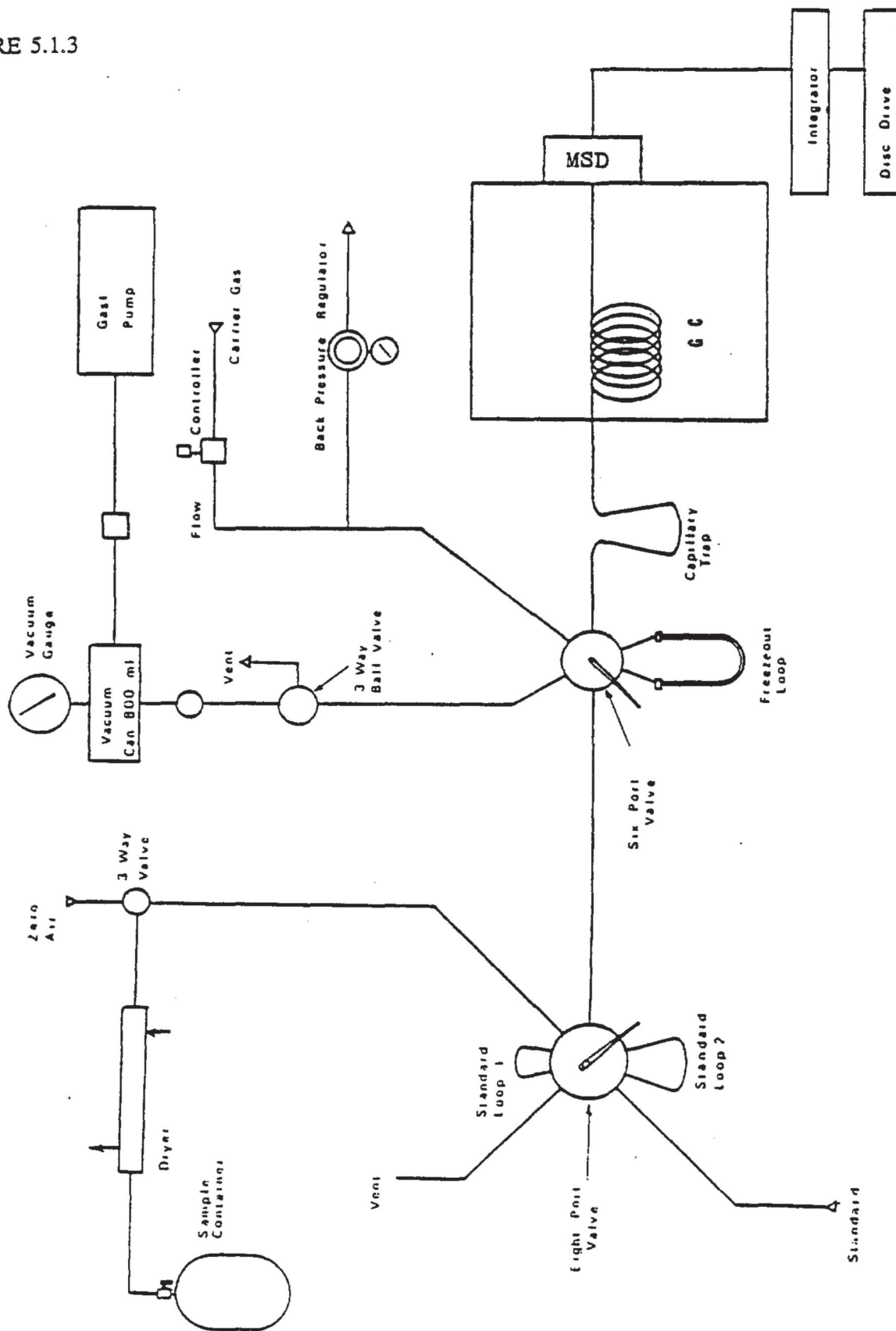

- c. Connect standard cylinder to sampling line.
- d. Open valve on standard cylinder and let bubble for 3 seconds to flush loop. Close valve.
- e. Rotate sample valve to inject position, start integrator.
- f. At end of run turn sample valve to load position.
- g. Disconnect standard cylinder.

2. Ambient Air Samples

This procedure can be used to load low pressure samples in stainless steel sample canisters, and to load low pressure standards at simulated ambient concentrations.

- a. Set system to operating parameters given in Table 5.1.b.
- b. Light FID, turn sample valve to load position.
- c. Connect sample canister to sampling line.
- d. Open valve on sample canister, and let bubble for 3 seconds to flush loop. Close valve.
- e. Turn sample valve to inject, and start integrator.
- f. At the end of the run, turn sample valve to load.
- g. Disconnect sample canister from sample intake line, record can pressure, place cap on sample canister, and place on table for light hydrocarbon analysis.

5.2.2 Light Hydrocarbon Analysis

This procedure is used to load standards at high concentrations (5 ppmv) and have them diluted using calibrated loops to give GC responses equivalent to ambient concentrations. Dilution is 1/1000 with an uncertainty of less than 5%.

- a. Set system to operating parameters given in Table 6.1.b.
- b. Light FID, turn on vacuum pump, turn on hot water, pour one Dewar of liquid oxygen, and place sample valve in the load position.
- c. Open vacuum valve and evacuate volume measuring canister to 22.0".
- d. Turn air sampling valve to zero air position.
- e. Connect standard input line of 6 port standard valve to standard cylinder. Set regulator on standard cylinder to 10 psig. Open regulator valve.
- f. Flush sample loop with zero air by opening intake valve and turning selector to vacuum. After a drop of 2" vacuum turn standard valve to load position. Turn selector to off and close intake valve. Re-evacuate volume measuring canister to 22".

- g. Place freezeout loop in liquid oxygen Dewar.
- h. Open valve on standard cylinder and let bubble for 3 seconds to flush loop. Close valve.
- i. Rotate standard valve to inject position, turn selector to vacuum.
- j. Let pressure rise until it reaches 10". This corresponds to a zero air volume of 500 mL.
- k. Close intake valve first then turn selector to off. Close valve on sample can.
- l. Turn sample valve to inject, remove liquid oxygen and immediately place freezeout loop in hot water bath and start integrator.
- m. At end of run, turn sample valve to load position and remove hot water bath.
- n. Turn regulator on standard cylinder off, and close regulator valve. Disconnect standard cylinder.

2. Ambient Air Samples

This procedure can be used to load low pressure samples in stainless steel sample canisters, and to load low pressure standards at simulated ambient concentrations.

- a. Set system to operating parameters given in Table 5.1.b.
- b. Light FID, turn on vacuum pump, turn on hot water, pour a Dewar of liquid oxygen, and place sample valve in the load position. Turn sampling line open to sample position.
- c. Open vacuum valve and evacuate volume measuring canister to 22.0".
- d. Connect sample canister to intake line.
- e. Open intake valve and turn selector to vacuum and flush system and glass bead freezeout loop to 22" vacuum.
- f. Close intake valve, and turn selector to off. Re-evacuate volume measuring canister to 22.0". Flush system with small amount of sample by opening selector valve and sample canister and re-evacuate volume measuring canister to 22.0".
- g. Place freezeout loop in liquid oxygen Dewar.
- h. Open valve on sample canister.
- i. Turn selector to vacuum and open intake valve. Let pressure rise in volume measuring canister until it reaches 10". This corresponds to a sample size of 500 mL.
- j. Close intake valve first then turn selector to off. Close valve on sample canister.
- k. Turn sample valve to inject, remove liquid oxygen Dewar replace with hot water bath, and start integrator.

- l. At end of run turn sample valve to inject position, and remove hot water bath.
- m. Disconnect sample canister from sample intake line, record can pressure, place cap on sample canister, and place on table for heavy hydrocarbon analysis.

5.2.3 Heavy Hydrocarbon Analysis

1. Hydrocarbon Standards

This procedure is used to load standards at high concentrations (5 ppmv) and have them diluted using calibrated loops to give GC responses equivalent to ambient concentrations. Dilution is 1/1000 with an uncertainty of less than 5%.

- a. Set system to operating parameters given in Table 5.1.b.
- b. Light FID, turn on vacuum pump, turn on hot water, pour two Dewars of liquid oxygen, and place sample valve in the load position.
- c. Open vacuum valve and evacuate volume measuring canister to 24.5".
- d. Turn intake valve to "zero air" position.
- e. Connect standard input line of 8 port standard valve to standard cylinder. Set regulator on standard cylinder to 10 psig. Open regulator valve.
- f. Flush both sample loops with zero air by opening intake valve and turning selector to vacuum. After a drop of 2" vacuum turn standard valve to flush other loop. After an additional 2" vacuum drop turn selector to off and close intake valve. Leave standard valve in position for desired loop size. Re-evacuate volume measuring canister to 24.5".
- g. Open valve on standard cylinder and let bubble for 3 seconds to flush loop. Close valve.
- h. Place freezeout loop in liquid oxygen Dewar.
- i. Rotate standard valve and turn selector to vacuum.
- j. Let pressure rise until it reaches 14". This corresponds to a zero air volume of 500 mL.
- k. Turn selector to off. Close valve on standard cylinder.
- l. Place capillary loop in liquid oxygen Dewar.
- m. Set timer for 2.5 min, and turn sample valve to inject.
- n. Remove liquid oxygen and place freezeout loop in hot water bath. Start timer.
- o. At 1.5 min set initial oven temperature to -20° C.
- p. After 2.5 min and oven temperature of -20° C, turn sample valve to load position, start integrator, and simultaneously pull out capillary loop.
- q. Remove hot water from freezeout loop.

- r. Turn cryo valve off at 25° C. CLEAR. ENTER OFF.
- s. Disconnect standard cylinder. Turn regulator on standard cylinder off, and close regulator valve.

2. Ambient Air Standards

This procedure can be used to load low pressure samples in stainless steel sample canisters, and to load low pressure standards at simulated ambient concentrations.

- a. Set system to operating parameters given in Table 5.1.b.
- b. Light FID, turn on vacuum pump, turn on hot water, pour two Dewars of liquid oxygen, and place sample valve in the load position.
- c. Open vacuum valve and evacuate volume measuring canister to 24.0".
- d. Turn intake valve to "sample" position.
- e. Open intake valve and turn selector to vacuum and flush system and glass bead freezeout loop to 22" vacuum.
- f. Close intake valve, and turn selector off. Re-evacuate volume measuring canister to 24.5".
- g. Flush system with a small amount of sample by turning selector to vacuum, open sample canister and let pressure rise to 22". Close sample canister, and turn selector to off. Re-evacuate volume measuring canister to 24.5".
- h. Place freezeout loop in liquid oxygen Dewar.
- i. Open valve on sample canister.
- j. Turn selector to vacuum and let pressure rise in volume measuring canister until it reaches 14". This corresponds to a sample size of 500 mL.
- k. Turn selector to off. Close valve on sample canister.
- l. Place capillary loop in liquid oxygen Dewar.
- m. Set timer for 2.5 min, and turn sample valve to inject.
- n. Remove liquid oxygen, place freezeout loop in hot water bath and simultaneously start timer.
- o. At 1.5 min set initial oven temperature to -20° C.
- p. After 2.5 min and oven temperature of -20° C, turn sample valve to load position, start integrator, and simultaneously pull our freezeout loop.
- q. Remove hot water from freezeout loop.
- r. Turn cryo valve off at 25° C. CLEAR. ENTER OFF.

- s. Disconnect sample canister from sample intake line, record can pressure, place cap on sample canister, and place on temporary storage shelf.

5.2.4 Attachment 1 Compounds by GC/MS

1. Standards

This procedure is used to load standards at high concentrations (5 ppmv) and have them diluted using calibrated loops to give GC responses equivalent to ambient concentrations. Dilution is 1/500 with an uncertainty of less than 5%.

- a. Set system to operating parameters.
- b. Turn on vacuum pump, turn on hot water, and pour two Dewars of liquid oxygen, and place Sample Valve in the load position.
- c. Open Vacuum Valve and evacuate Volume Measuring Canister to 24.5".
- d. Turn Intake Valve to "aero air" position.
- e. Connect Standard Input Line of 8 port Standard Valve to standard cylinder. Set regulator on standard cylinder to 10 psig. Open regulator valve.
- f. Flush both sample loops with zero air by opening Intake Valve and turning Selector to vacuum. After a drop of 2" vacuum turn standard valve to flush other loop. After an additional 2" vacuum drop turn Selector to off and close Intake Valve. Leave Standard Valve in position for desired loop size. Re-evacuate Volume Measuring Canister to 24.5".
- g. Open valve on standard cylinder and let bubble for 3 seconds to flush loop. Close valve.
- h. Place freezeout loop in liquid oxygen Dewar.
- i. Rotate Standard Valve and turn Selector to vacuum.
- j. Let pressure rise until it reaches 14". This corresponds to a zero air volume of 500 mL.
- k. Turn Selector to off. Close valve on standard cylinder.
- l. Place capillary loop in liquid oxygen Dewar.
- m. Set timer for 2.5 min, and turn Sample Valve to inject.
- n. Remove Liquid Oxygen and place freezeout loop in hot water bath. Start timer.
- o. On GC/MS computer enter the data acquisition program and set up data collection file for standard. Standard files are formatted as: S (Days Date) (Last digit of year) A (Run Number). D Turn on cryo option, and enter the Prepare To Inject Program.
- p. After 2.5 min and oven temperature of -20° C, turn Sample Valve to load position, hit the GO softkey on the computer, and simultaneously pull out capillary loop.

- q. Remove hot water from Freezeout loop.
- r. Turn cryo valve off at 25° C. CLEAR. ENTER OFF.
- s. Disconnect standard cylinder. Turn regulator on standard cylinder off, and close regulator valve.

2. Ambient Air Standards

This procedure can be used to load low pressure samples in stainless steel sample containers, and to load low pressure standards at simulated ambient concentrations.

- a. Set system to operating parameters given in Table 1.
- b. Open Vacuum Valve and evacuate Volume Measuring Canister to 24.0".
- c. Turn Intake Valve to "sample" position.
- d. Open Intake Valve and turn Selector to vacuum and flush system and glass bead Freezeout Loop at 22" vacuum.
- e. Close Intake Valve, and turn selector to off. Re-evacuate Volume Measuring Canister to 24.5".
- f. Flush system with a small amount of sample by turning Selector to vacuum, open Sample Canister and let pressure rise to 22". Close Sample Canister, and turn Selector to off. Re-evacuate Volume Measuring Canister to 24.5".
- g. Place Freezeout Loop in liquid oxygen Dewar.
- h. Open valve on Sample Canister.
- i. Turn Selector to vacuum and let pressure rise in Volume Measuring Canister until it reaches 14". This corresponds to a sample size of 500 mL.
- j. Turn Selector to off. Close valve on Sample Canister.
- k. Place Capillary Loop in liquid oxygen Dewar.
- l. Set timer for 2.5 min, and turn Sample Valve to inject.
- m. Remove liquid oxygen, place Freezeout Loop in hot water bath and simultaneously start timer.
- n. On GC/MS computer enter the data acquisition program and set up data collection file for standard. Standard files are formatted as: S(Days Date)(Last digit of year)A(Run Number).D Turn on cryo option, and enter the Prepare To Inject Program.
- o. After 2.5 min and oven temperature of -20°C, turn Sample Valve to load position, hit the GO softkey on the computer, and simultaneously pull out capillary loop. Min set initial oven temperature to -20° C.
- p. Remove hot water from Freezeout Loop.

- q. Turn cryo valve off at 25° C. CLEAR. ENTER OFF.
- r. Disconnect Sample Canister from Sample Intake Line, record can pressure, place cap on Sample Canister, and place on temporary storage shelf.

5.2.5 Permanent Gases

1. Standards

- a. Set system to operating parameters.
- b. Light FID, turn on TCD, and place sample valve in load position.
- c. Connect standard cylinder to sampling line.
- d. Open valve on standard cylinder and let bubble for 3 seconds to flush loop. Close valve.
- e. Rotate sample valve to inject position, start integrator.
- f. Turn second column valve to out position at 1.6 min.
- g. Turn second column valve to in position at 8.0 min.
- h. At end of run turn sample valve to load position.
- i. Disconnect standard cylinder.

2. Ambient Air Samples

This procedure can be used to load low pressure samples in stainless steel sample canisters, and to load low pressure standards at simulated ambient concentrations.

- a. Set system to operating parameters.
- b. Light FID, turn on TCD, and turn sample valve to load position.
- c. Connect sample canister to sampling line.
- d. Open valve on sample canister, and let bubble for 3 seconds to flush loop. Close valve.
- e. Turn sample valve to inject, and start integrator.
- f. Turn second column valve to out position at 1.6 min.
- g. Turn second column valve to in position at 8.0 min.
- h. At the end of the run, turn sample valve to load.
- i. Disconnect sample canister from sample intake line, record can pressure, place cap on sample canister, and place on table for light hydrocarbon analysis.

5.3 Calibration Standards

There are two types of calibrations performed for the hydrocarbon analysis. One is for the amount of the various hydrocarbons present and the second is for the identification of the retention times of the different hydrocarbons species.

5.3.1 Quantitative Standards

The concentrations of the individual hydrocarbons were determined by their uniform carbon response on the FID. This procedure is the recommended calibration procedure and has been shown to be accurate to 5 to 8% (Lonneman, 1979). The primary calibration standard used for the light and heavy hydrocarbons is a NBS traceable reference gas standard obtained from Scott-Marrin, Riverside, CA. The specifications of the standard are shown in Figure 5.3.1.(a) the light hydrocarbon fraction is calibrated against propane and the non-aromatic fraction of the heavy hydrocarbons are calibrated against hexane. The aromatic hydrocarbons are calibrated against benzene. The standard cylinder is returned every year for recalibration by the manufacturer. The concentrations of the hydrocarbons in the standard are converted to parts per billion carbon (ppbC) using the procedure described by Westbert et. al. (1984).

The concentrations of the individual compounds are determined by using an External Calibration procedure, in which the compound's response is compared to the response of a standard. The primary calibration standard is an NIST traceable reference gas standard obtained from Scott-Marrin, Inc., Riverside, CA. The specifications of the standard are shown in Figure B.5.3.1(b) & (c) The standard cylinder is returned every six months for recalibration by the manufacturer. In addition, a standard containing toluene, o-xylene, ethene and propene is used to verify response for these compounds.

Standards for aldehyde determinations were prepared as described in ARB Method 110.

Intercomparison of the light and heavy hydrocarbon runs can be made using both the propane peak and the hexane peak. The propane peak can be used because the heavy loaded column is capable of separating the lighter hydrocarbons.

5.3.2 Qualitative Calibration

The retention times were calibrated against commercial gas standard blends of different hydrocarbons and from laboratory standards prepared from neat materials.

The commercial gas blends are available from Ideal Gas Products and Scott Specialty Gases. These standards are used to establish retention times and to check concentrations obtained from the NBS traceable standard.

Laboratory standards are prepared from pure materials for those compounds not available in gas blends. Known quantities of the pure materials are diluted with a measured volume of "zero air". Dilutions are made in stainless steel canisters and are stable for use in retention time calibrations for several months.



SCOTT-MARRIN, INC.
 2001 THIRD ST. • UNIT H • RIVERSIDE, CA 92507
 TELEPHONE (714) 784-1240

Appendix AA
 Revision 0
 August 1987
 Page 44 of 6

REPORT OF ANALYSIS

TO: Steve Hoyt
 Environmental Analytical Science
 3576 Empleo St., Suite 5
 San Luis Obispo, CA 93401

DATE: 23 October 1986

CUSTOMER ORDER NUMBER: 1171

CYLINDER NUMBER <u>CC121</u>	CYLINDER NUMBER _____
COMPONENT	CONCENTRATION(v/v)
Propane	4.71 ± 0.05 ppm
n-Hexane	5.12 ± 0.1 ppm
Benzene	5.01 ± 0.1 ppm
Nitrogen	Balance

CYLINDER NUMBER _____	CYLINDER NUMBER _____
COMPONENT	CONCENTRATION(v/v)
COMPONENT	CONCENTRATION(v/v)

ANALYST *M. C. Dodd*
 M. C. Dodd

APPROVED *J.T. Marrin*
 J.T. Marrin

The only liability of this company for gas which fails to comply with this analysis shall be replacement or reanalysis thereof by the company without extra cost.

FIGURE 5.3.1.(a2)



SCOTT-MARRIN, INC.
2001 THIRD ST. • UNIT H • RIVERSIDE, CA 92507
TELEPHONE (714) 784-1240

REPORT OF ANALYSIS

TO:

Steve Hoyt
Environmental Analytical Services
3576 Empleo, Suite #5
San Luis Obispo, CA 93401

DATE:

5 November 1987

CUSTOMER ORDER NUMBER: 1253

~~~~~  
CYLINDER NUMBER CC62416

| COMPONENT               | CONCENTRATION(v/v) |
|-------------------------|--------------------|
| Vinyl Chloride          | 5.14 ± 0.1 ppm     |
| Dibromomethane          | 5.25 ± 0.1 ppm     |
| Trichloromethane        | 0.515 ± 0.01 ppm   |
| 1,2-Dichloroethane      | 5.20 ± 0.1 ppm     |
| 1,1,1-Trichloroethane   | 0.520 ± 0.01 ppm   |
| Tetrachloromethane      | 0.525 ± 0.01 ppm   |
| 1,2-Dichloroethylene    | 0.530 ± 0.01 ppm   |
| Benzene                 | 5.25 ± 0.1 ppm     |
| 1,2-Dibromoethane       | 5.29 ± 0.1 ppm     |
| 1,1,2-Trichloroethylene | 0.530 ± 0.01 ppm   |
| Nitrogen                | Balance            |

ANALYST

*M. Dodd*

M. Dodd

The only liability of this company for gas which fails to conform to specifications shall be replacement or reanalysis thereof by the company without extra cost.

APPROVED

*J. T. Marrin*

J. T. Marrin

Analysis shall be replacement or reanalysis thereof by the company without extra cost.



**SCOTT-MARRIN, INC.**  
2001 THIRD ST. • UNIT H • RIVERSIDE, CA 92507  
TELEPHONE (714) 784-1240

## REPORT OF ANALYSIS

TO:

Steve Hoyt  
Environmental Analytical Services  
3576 Empleo Street, Ste. 5  
San Luis Obispo, CA 93401

DATE:

12 September 1988

CUSTOMER ORDER NUMBER: 1367

~~~~~  
CYLINDER NUMBER CC68692

COMPONENT	CONCENTRATION(v/v)
Halocarbon-12	5.20 ± 0.1 ppm
Halocarbon-11	4.40 ± 0.1 ppm
1,1-Dichloroethylene	4.87 ± 0.1 ppm
1,1-Dichloroethane	5.05 ± 0.1 ppm
1,1,2-Trichloroethane	5.20 ± 0.1 ppm
Nitrogen	Balance

ANALYST

J. W. Gay

APPROVED

J. T. Marrin

The only liability of this company for gas which fails to co
company without extra cost.

analysis shall be replacement or reanalysis thereof by the

5.4 Calibration Procedures

5.4.1 Methane

The methane analyzer was calibrated by passing the methane standard through a 1.0 mL calibrated sample loop. The standard was then injected onto the column according to the standard operating procedures. The concentration of the methane is determined using the following formula.

$$\text{Methane (ppmC)} = \text{Standard Conc. (ppmv)} * 1 * (\text{Sample Area/Standard Area})$$

The factor of one accounts for the one carbon atom in methane.

5.4.2 Hydrocarbons

The light and heavy hydrocarbons were calibrated by using a dilution of the 5 ppm NBS traceable standard. A summary of the calibration procedures is shown in Table 5.4.2. The daily calibration consists of a zero point and two calibration points (10% and 100% of range). One calibration point is run at the beginning of the day and one at the end of the day. Weekly, a three point calibration is run to verify the linearity of the instrument. During the monthly internal audit of the analytical system a 5 point calibration curve is run to establish performance criteria for the system.

Standards were prepared using a gas dilution system on the gas chromatograph or by making static dilutions to atmospheric levels. The gas dilution system is constructed from an 8 port gas sampling valve with a 0.05 mL, 0.5 mL, and 5.0 sample loops. The loops are filled with the standard and flushed with "zero air" prepared with an AADCÓ Model 737 pure air generator. The three loop sizes are used to prepare a three point calibration of the system to check the linearity in the concentration range of interest. The gas dilution system is used for the daily instrument calibration. The concentration of the individual hydrocarbons is determined using the following formula:

$$\text{Hydrocarbon (ppbC)} = \text{Standard Conc. (ppbv)} * \text{number of carbons} * (\text{Sample Area/Standard Area})$$

Standards at atmospheric concentration levels were prepared by diluting the NBS traceable standard in stainless steel canisters. The standards are diluted by using a calibrated syringe to inject a measured volume of NBS traceable standard into a passivated stainless steel canister. The canister is filled with a known volume of zero air measured using a mass flow meter. The diluted standards are run in exactly the same manner as the samples and serve as a check of the sample concentration and injection system.

5.4.3 GC/MS Compounds

The GC/MS Compounds were calibrated using a dilution of the NBS traceable standard. The daily calibration consists of a zero point and two calibration points (10% and 100% of range). One calibration point is run at the beginning of the day and one at the end of the day. Weekly, a three point calibration is run to verify the linearity of the instrument. During the monthly internal audit of the analytical system a 5 point calibration curve is run to establish performance criteria for the system.

Standards were by using a gas dilution system on the gas chromatograph or by making static dilutions to atmospheric levels. The gas dilution system is constructed from an 8 port gas sampling valve with a 0.05 mL, 0.5 mL, and 5.0 sample loops. The loops are filled with the standard and flushed with "zero air" prepared with an AADCÓ Model 737 pure air generator. The three loop sizes are used to prepare a three point calibration of the system to check the linearity in the concentration range of interest. The gas dilution system is used for the daily instrument calibration.

The concentration of the individual hydrocarbons is determined using the following formula:

$$\text{Compound (ppbv)} = \text{Std. Conc. (ppbv)} * (\text{Sample Area/Std. Area}) * (\text{Std. Volume/Sample Volume})$$

Standards at atmospheric concentration levels were prepared by diluting the NBS traceable standard in stainless steel canisters. The standards were diluted using a calibrated syringe to inject a measured volume of the NBS traceable standard into a passivated stainless steel canister. The canister is filled with a known volume of zero air measured using a mass flow meter. This ambient level standard is sent to another laboratory for calibration against the NBS 5 ppbv VOC standard. The diluted standard is run in exactly the same manner as the samples and serves as a check of the sample concentration injection system.